

# **DS-6500/DS-7500 User's Guide**



---

# Contents

<b>DS-6500/DS-7500 User's Guide</b> .....	<b>7</b>
<b>Scanner Basics</b> .....	<b>8</b>
Scanner Parts .....	8
Scanner Buttons and Lights .....	11
User Replaceable Epson Scanner Parts .....	11
Changing the Power Off Setting .....	12
<b>Placing Originals on the Scanner</b> .....	<b>14</b>
Placing Originals on the Scanner Glass .....	14
Placing Originals in the Automatic Document Feeder .....	17
Placing Originals in the ADF .....	17
Original Document Specifications for the ADF .....	18
<b>Scanning</b> .....	<b>20</b>
Starting a Scan.....	20
Starting a Scan from a Scanner Button.....	20
Adding and Assigning Scan Jobs with Document Capture Pro - Windows .....	21
Adding and Assigning Scan Jobs with Document Capture - Mac.....	24
Starting a Scan Using the Epson Scan 2 Icon .....	24
Starting a Scan from a Scanning Program.....	27
Scanning with Document Capture Pro - Windows .....	29
Scanning with Document Capture - Mac .....	33
Scanning in Epson Scan 2 .....	36
Additional Scanning Settings - Main Settings Tab .....	40
Additional Scanning Settings - Advanced Settings Tab .....	42
Image Format Options .....	44
Scan Resolution Guidelines .....	44
Scanning Special Projects.....	45
Scanning Multi-Page Originals as Separate Files - Windows .....	45
Saving a Scan as an Office Format File - Windows .....	49
<b>Cleaning and Transporting Your Scanner</b> .....	<b>52</b>
Cleaning Your Scanner .....	52

Checking the Scanner Roller Counter .....	56
Replacing the Scanner Rollers .....	56
Resetting the Scanner Roller Counter .....	62
Transporting Your Scanner .....	62
<b>Solving Problems .....</b>	<b>64</b>
Scanner Light Status .....	64
Solving Scanning Problems .....	65
Scanner Does Not Turn On or Turns Off Unexpectedly .....	66
Start Button Does Not Work as Expected .....	66
Scanning Software Does Not Operate Correctly .....	66
Cannot Start Epson Scan 2 .....	67
Scanning is Slow .....	68
Solving Original Document Feeding Problems .....	68
Originals Do Not Feed From the Automatic Document Feeder .....	68
Original Jams in Scanner ADF .....	69
Solving Scanned Image Quality Problems .....	71
Scanned Image Quality Problems .....	72
Image Consists of a Few Dots Only .....	73
Line of Dots Appears in All Scanned Images .....	73
Straight Lines in an Image Appear Crooked .....	74
Image Colors are Patchy at the Edges .....	74
Binding Margins on a Scanned Booklet are Blurry .....	74
Ripple Patterns Appear in an Image .....	75
Scanned Image Edges are Cropped .....	75
Characters are not Recognized During Conversion to Editable Text (OCR) .....	75
Resetting the Epson Scan 2 Settings .....	76
Uninstall Your Scanner Software .....	77
Uninstalling Scanner Software .....	77
Uninstalling Scanner Software - Mac .....	77
Where to Get Help .....	78
<b>Technical Specifications .....</b>	<b>80</b>
Windows System Requirements .....	80
Mac System Requirements .....	81

General Specifications .....	81
Dimension Specifications .....	82
Electrical Specifications .....	83
Environmental Specifications .....	83
Safety and Approvals Specifications .....	84
<b>Notices .....</b>	<b>85</b>
Important Safety Instructions.....	85
Restrictions on Copying .....	87
Default Delay Times for Power Management for Epson Products.....	87
Binding Arbitration and Class Waiver .....	88
Trademarks .....	91
A Note Concerning Responsible Use of Copyrighted Materials .....	91
Copyright Notice.....	91
Copyright Attribution .....	92



---

## **DS-6500/DS-7500 User's Guide**

Welcome to the DS-6500/DS-7500 *User's Guide*.

For a printable PDF copy of this guide, [click here](#).

---

# Scanner Basics

See these sections to learn about the basic features of your scanner.

[Scanner Parts](#)

[Scanner Buttons and Lights](#)

[User Replaceable Epson Scanner Parts](#)

[Changing the Power Off Setting](#)

## Scanner Parts

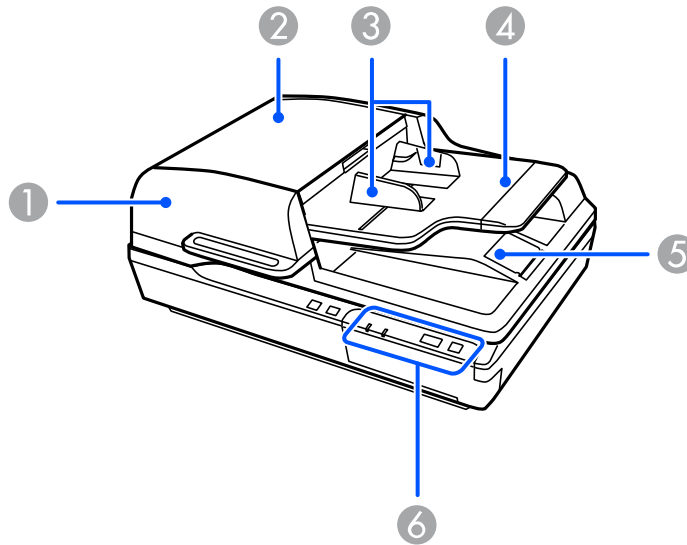

- 1 Automatic Document Feeder (ADF)
- 2 ADF cover
- 3 ADF edge guides
- 4 ADF input tray
- 5 ADF output tray



6 Control panel

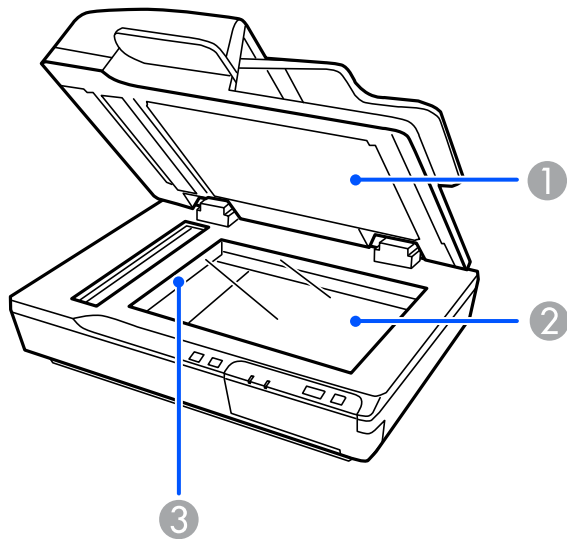

- 1 Document cover (do not remove the document mat inside the document cover)
- 2 Scanner glass

### 3 Carriage (beneath scanner glass)

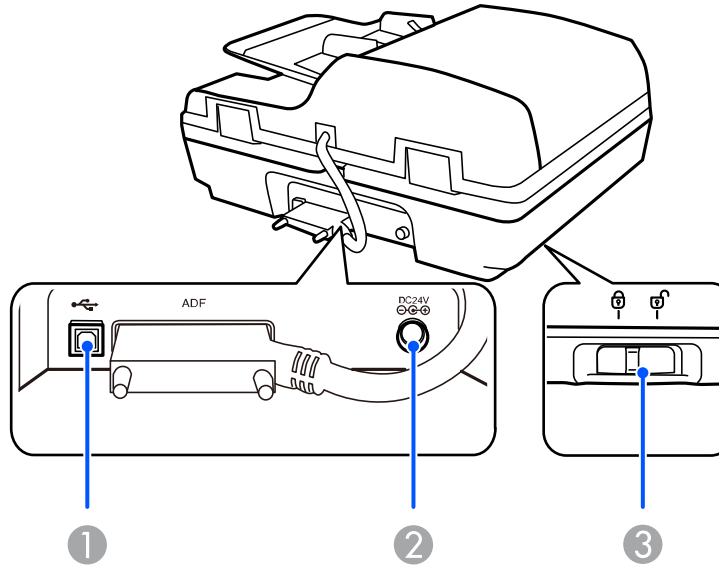



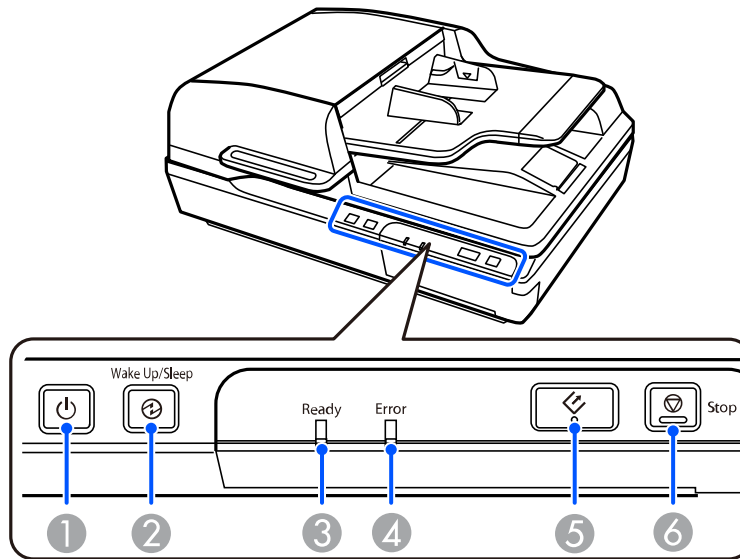

- 1 USB port
- 2 DC inlet
- 3 Transportation lock

Parent topic: [Scanner Basics](#)

## Scanner Buttons and Lights



- 1  power button and light
- 2  **Wake Up/Sleep** button and light
- 3 **Ready** light
- 4 **Error** light
- 5  start button
- 6  **Stop** button

Parent topic: [Scanner Basics](#)

## User Replaceable Epson Scanner Parts

You can purchase genuine Epson accessories at [epson.com](http://epson.com) (U.S. sales), [epson.ca](http://epson.ca) (Canadian sales), or [epson.com.jm](http://epson.com.jm) (Caribbean sales). You can also purchase accessories from an Epson authorized reseller. To find the nearest one, call 800-GO-EPSON (800-463-7766) in the U.S. or 800-807-7766 in Canada.

**Note:** Availability of accessories varies by country.



Part	Part number
Epson Network Scan Module	B12B808411
Roller Assembly Kit	B12B813481
Cleaning Kit	B12B819291

**Note:** See the documentation that came with the optional Epson Network Scan Module for instructions on connecting it to your scanner and scanning over a network.

Parent topic: [Scanner Basics](#)

## Changing the Power Off Setting

You can use the Epson Scan 2 Utility to change the time period before the scanner turns off automatically.

1. Do one of the following to access the Epson Scan 2 Utility:
  - **Windows 10:** Click  and select **EPSON > Epson Scan 2 Utility**.
  - **Windows 8.x:** Navigate to the **Apps** screen and select **Epson Scan 2 Utility**.
  - **Windows (other versions):** Click  or **Start**, and select **All Programs** or **Programs**. Select **EPSON > Epson Scan 2 > Epson Scan 2 Utility**.
  - **Mac:** Open the **Applications** folder, open the **Epson Software** folder, and select **Epson Scan 2 Utility**.

2. Click the **Power Save** tab.

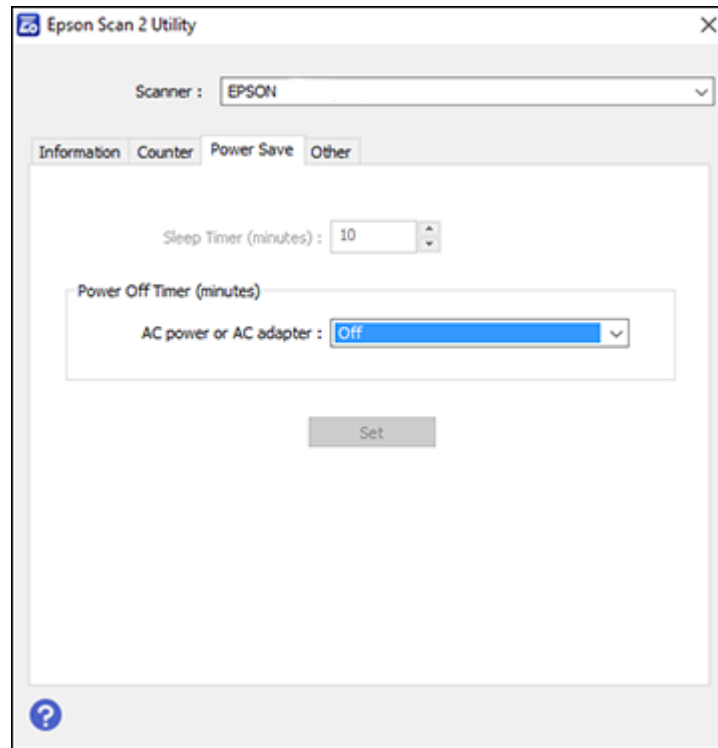

3. Select the length of time after which you want the scanner to automatically turn off when not in use as the **Power Off Timer** setting.
4. Close the Epson Scan 2 Utility.

**Parent topic:** [Scanner Basics](#)

---

## Placing Originals on the Scanner

Follow the instructions here to place your originals on the scanner.

**Caution:** Do not place anything on top of your scanner or use its cover as a writing surface to avoid damaging it.

[Placing Originals on the Scanner Glass](#)

[Placing Originals in the Automatic Document Feeder](#)

### Placing Originals on the Scanner Glass

You can place originals directly on the scanner glass.

**Caution:** Do not place heavy objects on the scanner glass and do not press on the glass with too much force, or it may damage the scanner. Do not leave photos on the scanner glass for an extended period, or they may stick to the glass.

1. Open the document cover.

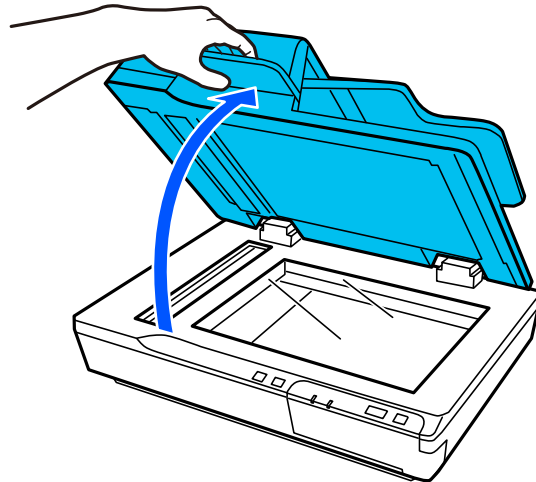

2. Place your original facedown on the scanner glass with the top edge facing as shown. You can also place a large original or a thick document up to 0.6 inch [15 mm] thick on the scanner glass. Slide the original to the edges of the indicated corner.

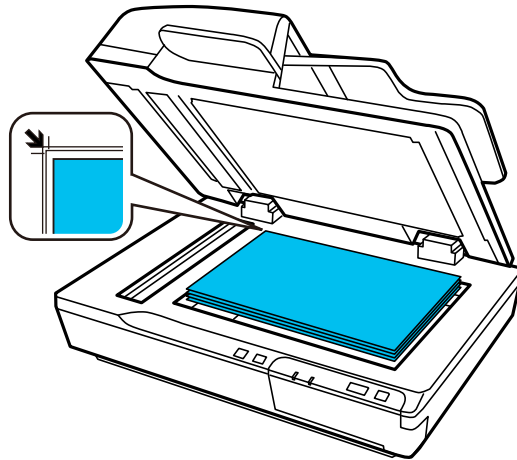
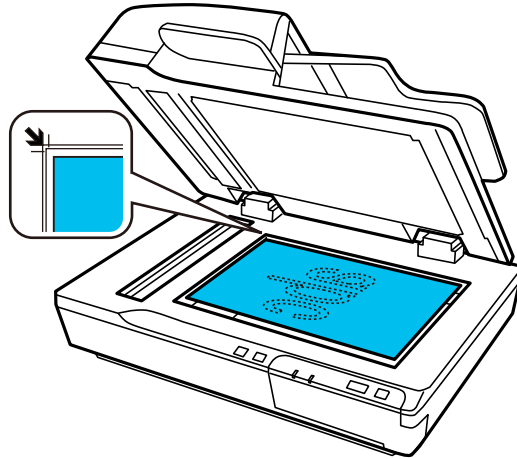

**Note:** The edges of your original may be cropped by 0.06 inch (1.5 mm) from the edge of the scanner glass. Manually position your original away from the edges to prevent cropping.

3. Do one of the following:

- Close the document cover gently to keep your original in place.

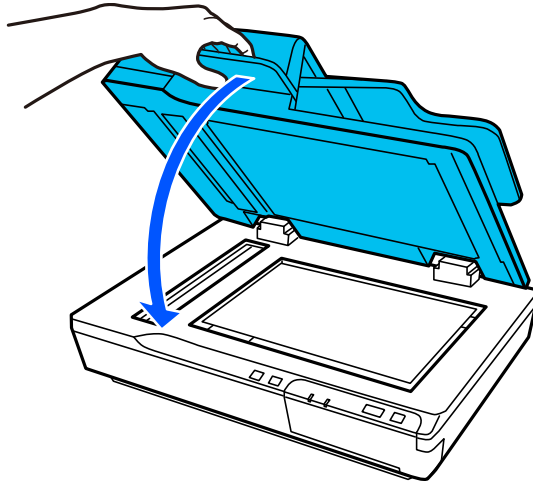

- If you are scanning a book or other thick document, close the document cover and gently hold it down as you scan.

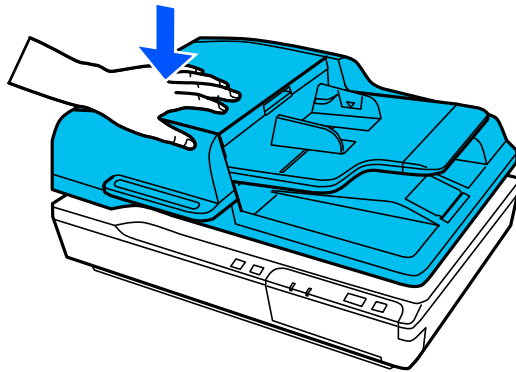

**Note:** If your thick original is curled at the edges, cover the edges with paper to block external light as you scan.



Parent topic: [Placing Originals on the Scanner](#)

## Placing Originals in the Automatic Document Feeder

Follow the instructions here to place your originals in the Automatic Document Feeder (ADF).

[Placing Originals in the ADF](#)

[Original Document Specifications for the ADF](#)

Parent topic: [Placing Originals on the Scanner](#)

## Placing Originals in the ADF

You can place multi-page original documents in the Automatic Document Feeder (ADF).

**Caution:** Make sure your originals meet the specifications for the ADF before loading them.

1. Remove any documents from the scanner glass and make sure there is no dust on the glass.
2. Slide the ADF edge guides outward all the way. Then open the paper stopper in the ADF output tray as shown.

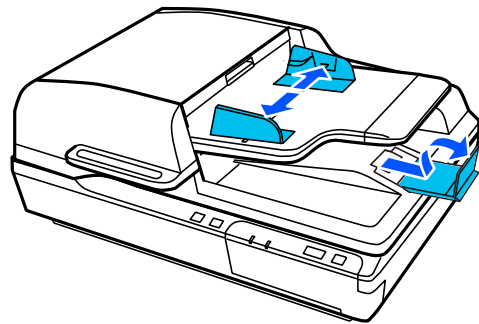

3. Fan your stack of originals and tap them gently on a flat surface to even the edges.

4. Insert the originals into the ADF faceup and top-edge first, then slide the edge guides against the originals, but not too tightly.

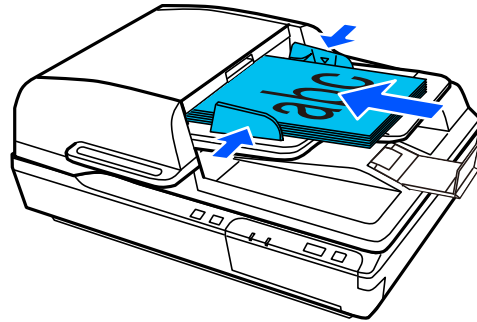

**Note:** Do not load originals above the arrow mark on the inside of the ADF edge guides. Do not load additional originals during scanning.

**Parent topic:** [Placing Originals in the Automatic Document Feeder](#)

**Related references**

[Original Document Specifications for the ADF](#)

## Original Document Specifications for the ADF

You can load original documents that meet these specifications in the ADF.

Size	Width: 3.9 inches (100 mm) to 8.5 inches (215.9 mm) Length: 5.8 inches (148 mm) to 40 inches (1016 mm)
Weight	Larger than A6 size: 50 to 128 g/m <sup>2</sup> A6 or smaller size: 60 to 190 g/m <sup>2</sup>
Paper type	Plain paper, high-quality paper, or recycled paper

**Caution:** Load the following types of originals on the scanner glass instead of the ADF, or they may be damaged or may damage the scanner:

- Photos
- Booklets

- Non-paper originals, such as fabric or metal foil
- Originals on glossy paper
- Originals containing staples or paper clips
- Originals with glue on it
- Ripped, curled, folded, or wrinkled originals
- Transparencies
- Originals with carbon paper backing
- Originals with wet ink
- Originals with sticky notes attached
- Originals with labels or tape not firmly attached

**Parent topic:** [Placing Originals in the Automatic Document Feeder](#)

---

# Scanning

You can scan your originals and save them as digital files.

[Starting a Scan](#)

[Scanning with Document Capture Pro - Windows](#)

[Scanning with Document Capture - Mac](#)

[Scanning in Epson Scan 2](#)

[Scan Resolution Guidelines](#)

[Scanning Special Projects](#)

## Starting a Scan

After placing your originals on your product for scanning, start scanning using one of these methods.

[Starting a Scan from a Scanner Button](#)

[Starting a Scan Using the Epson Scan 2 Icon](#)

[Starting a Scan from a Scanning Program](#)

**Parent topic:** [Scanning](#)

**Related topics**

[Placing Originals on the Scanner](#)

## Starting a Scan from a Scanner Button

You can scan using the  start button on your scanner. This automatically starts Document Capture Pro (Windows) or Document Capture (Mac) and the scan job you have assigned to the button.

**Note:** Make sure Epson Scan 2 and either Document Capture Pro (Windows) or Document Capture (Mac) are installed on the computer connected to the scanner.

1. Make sure the scanner is connected to your computer or network.
2. Load an original in your scanner.
3. Press the  start button.

The scanner starts the job that was assigned to the  start button in Document Capture Pro (Windows) or Document Capture (Mac).

**Note:** You can view or change the scan settings using Document Capture Pro (Windows) or Document Capture (Mac).

[Adding and Assigning Scan Jobs with Document Capture Pro - Windows](#)

[Adding and Assigning Scan Jobs with Document Capture - Mac](#)



**Parent topic:** [Starting a Scan](#)

### **Adding and Assigning Scan Jobs with Document Capture Pro - Windows**

You can view, change, or add available default scan settings when you scan using the  start button on your product. You do this by accessing the scan jobs in the Document Capture Pro program.

**Note:** The settings may vary, depending on the software version you are using. See the help information in Document Capture Pro for details.

1. Do one of the following to start Document Capture Pro:

- **Windows 10:** Click  and select **Epson Software > Document Capture Pro**.
- **Windows 8.x:** Navigate to the **Apps** screen and select **Document Capture Pro**.
- **Windows (other versions):** Click  or **Start**, and select **All Programs** or **Programs**. Select **Epson Software > Document Capture Pro**.

You see the Document Capture Pro window.

2. If you see a **Switch to Simple View** button in the upper right corner of the window, click it.

You see a window like this:

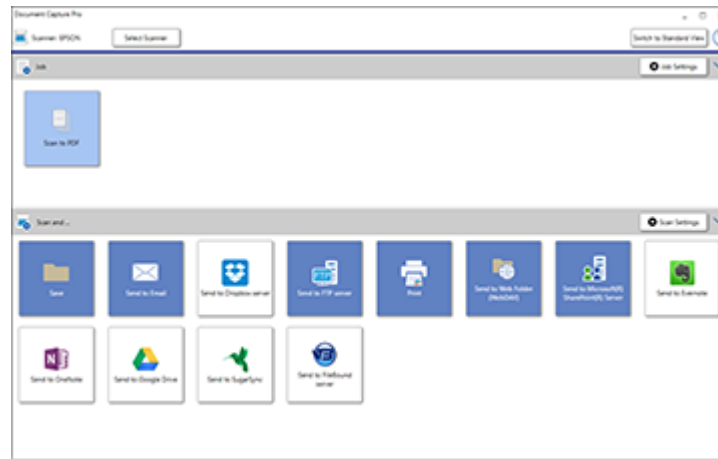

3. Click the **Job Settings** button.

**Note:** If you do not see the button, click the < symbol in the **Job** bar.



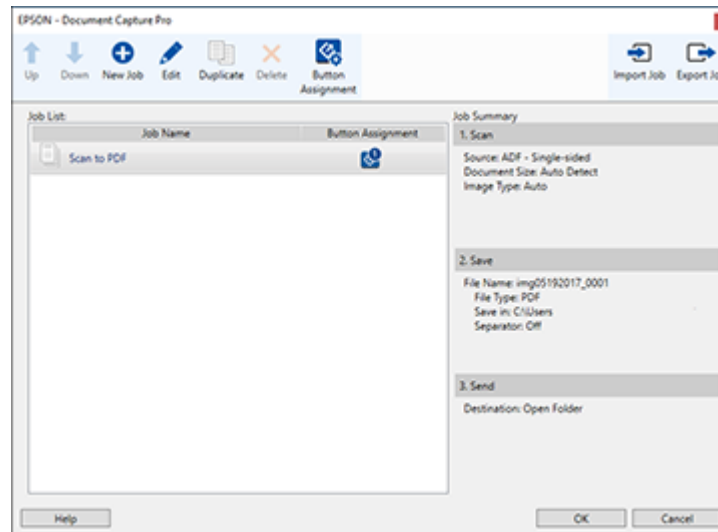

You see a window like this:



4. To add a scan job, click the  **New Job** icon, enter a name for the new job, select settings as necessary, and click **OK**.

You can now use the new scan job when you scan with Document Capture Pro.

**Note:** See the Help information in Document Capture Pro for details.

5. To assign a scan job to the  start button, click the  **Button Assignment** icon.
6. Select the job that you want to assign to the  start button from the  drop-down list.
7. Click **OK**, then click **OK** again.

You can now use the assigned scan job when you scan with the  start button on your product.

**Parent topic:** [Starting a Scan from a Scanner Button](#)

#### **Related topics**

[Placing Originals on the Scanner](#)



## Adding and Assigning Scan Jobs with Document Capture - Mac

You can view, change, or add available default scan settings when you scan using the  start button on your product. You do this by accessing the scan jobs in the Document Capture program.

1. Start Document Capture on a computer connected to the product.
2. Click the  Manage Job icon from the toolbar at the top of the window.  
You see a window showing the current scan job list.
3. To add a scan job, click the **+** icon, enter a name for the new job, select settings as necessary, and click **OK**.

You can now use the new scan job when you scan with Document Capture.

**Note:** See the Help information in Document Capture for details.

4. To assign a scan job to the  start button on your scanner, click the  icon at the bottom of the window and click **Event Settings**.
5. Select the job that you want to assign to the  start button from the **1** drop-down list.
6. Click **OK**, then click **OK** again.

You can now use the assigned scan job when you scan with the  start button on your product.

**Parent topic:** [Starting a Scan from a Scanner Button](#)

### Related topics

[Placing Originals on the Scanner](#)

## Starting a Scan Using the Epson Scan 2 Icon

You can start the Epson Scan 2 program to select scan settings, scan, and save the scanned image to a file.

**Note:** If you are using your Epson product with the Windows 10 S operating system, you cannot use the software described in this section. You also cannot download and install any Epson product software from the Epson website for use with Windows 10 S; you must obtain software only from the Windows Store.

- **Windows 10:** Click  and select **EPSON > Epson Scan 2**.
- **Windows 8.x:** Navigate to the **Apps** screen and select **Epson Scan 2**.



- **Windows (other versions):** Click  or **Start**, and select **All Programs** or **Programs**. Select **EPSON** > **Epson Scan 2** > **Epson Scan 2**.
- **Mac:** Open the **Applications** folder, open the **Epson Software** folder, and select **Epson Scan 2**.

You see an Epson Scan 2 window like this:

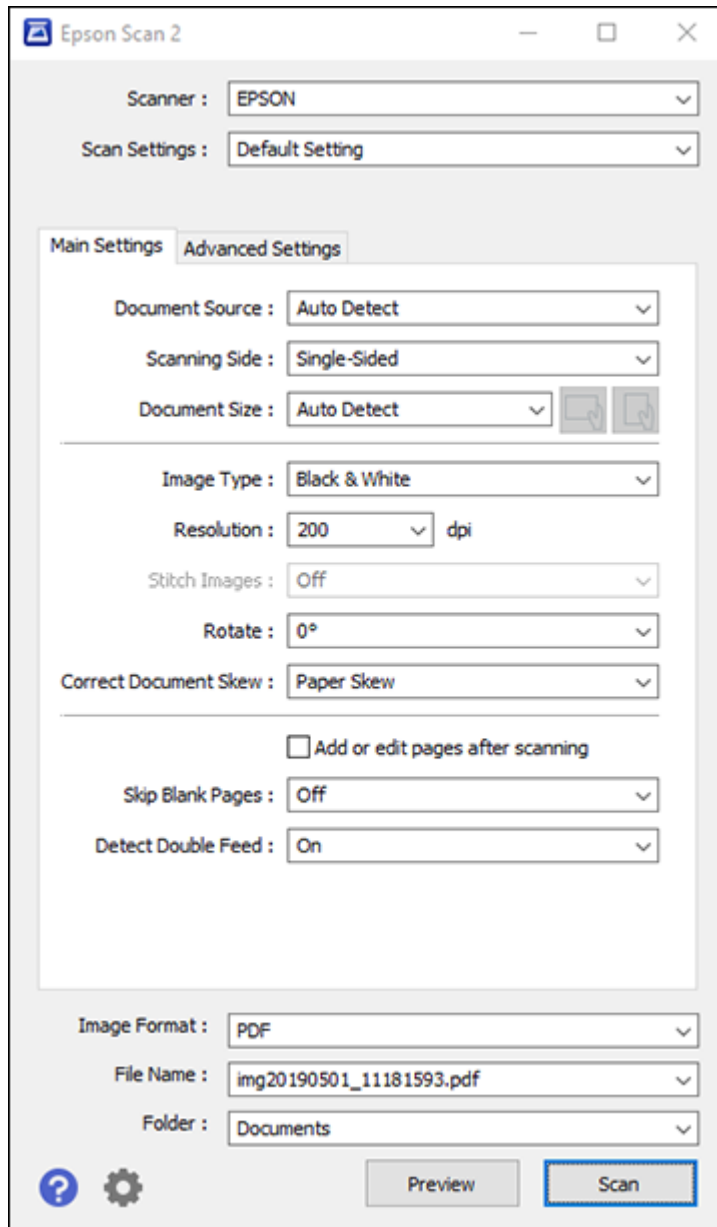

**Parent topic:** [Starting a Scan](#)

**Related tasks**

[Scanning in Epson Scan 2](#)

## Starting a Scan from a Scanning Program

You can start Epson Scan 2 from a TWAIN-compliant scanning program to select scan settings, scan, and open the scanned image in the program.

**Note:** If you are using your Epson product with the Windows 10 S operating system, you cannot use the software described in this section. You also cannot download and install any Epson product software from the Epson website for use with Windows 10 S; you must obtain software only from the Windows Store.

1. Open your scanning program and select its scanning option. (See your scanning program help for instructions.)
2. Select your product.

**Note:** In certain programs, you may need to select your product as the "source" first. If you see a **Select Source** option, choose it and select your product. With Windows, do not select a **WIA** option for your product; not all scan functions will be available.

You see an Epson Scan 2 window like this:

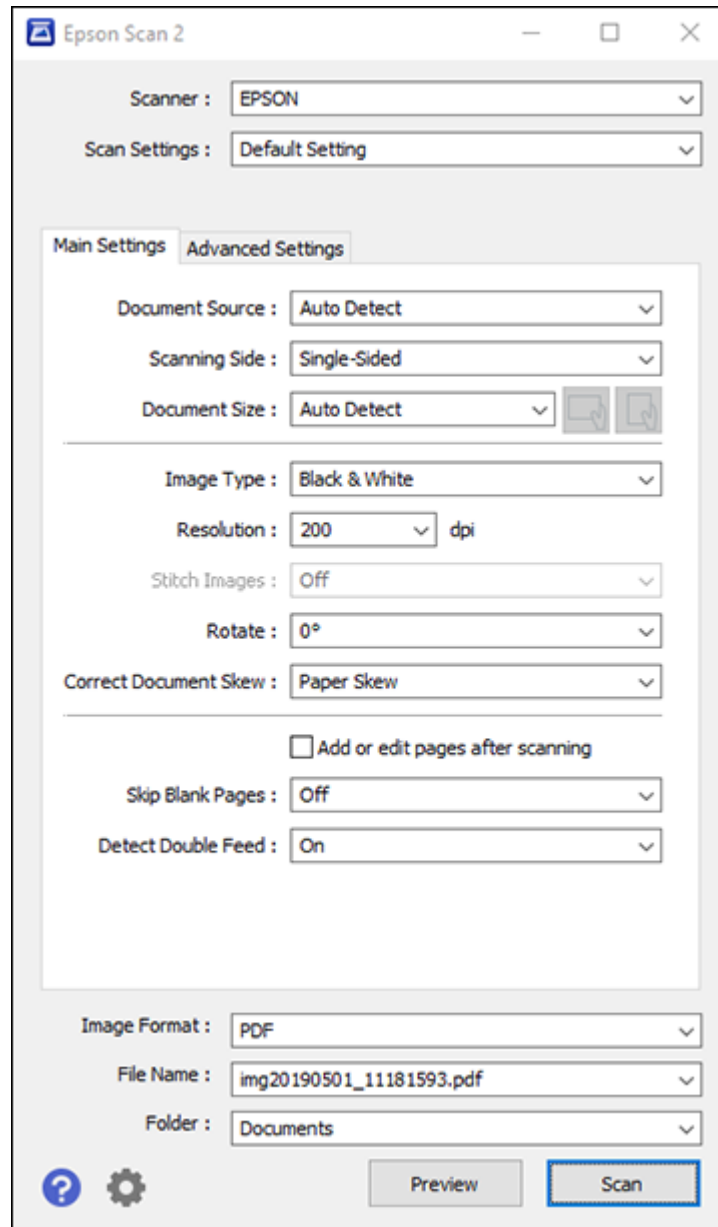

Parent topic: [Starting a Scan](#)

### Related tasks



[Scanning in Epson Scan 2](#)

## Scanning with Document Capture Pro - Windows

When you scan with Document Capture Pro, the program automatically saves your scanned file on your computer in the folder you specify. You can select settings, preview, and change the scanned file settings as necessary.

**Note:** The settings may vary, depending on the software version you are using. See the Help information in Document Capture Pro for details.

1. Do one of the following to start Document Capture Pro:

- **Windows 10:** Click  and select **Epson Software > Document Capture Pro**.
- **Windows 8.x:** Navigate to the **Apps** screen and select **Document Capture Pro**.
- **Windows (other versions):** Click  or **Start**, and select **All Programs** or **Programs**. Select **Epson Software > Document Capture Pro**.

You see this window:

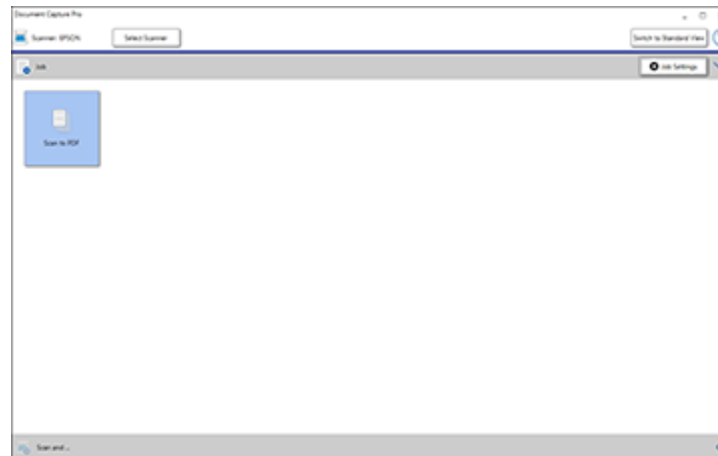

**Note:** Click **Switch to Simple View**, if necessary.

2. Click **Select Scanner** and select your scanner from the scanner list, if necessary.
3. Click one of the job icons or click the arrow next to the Job Settings button to select a different format.
4. If you want to select detailed scan settings, click **Switch to Standard View** and select **Scan Settings** from the Scan Setting Name list.

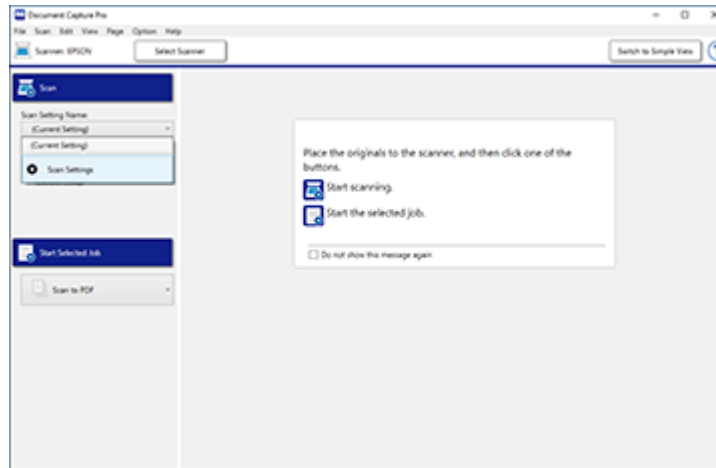

You see a window like this:

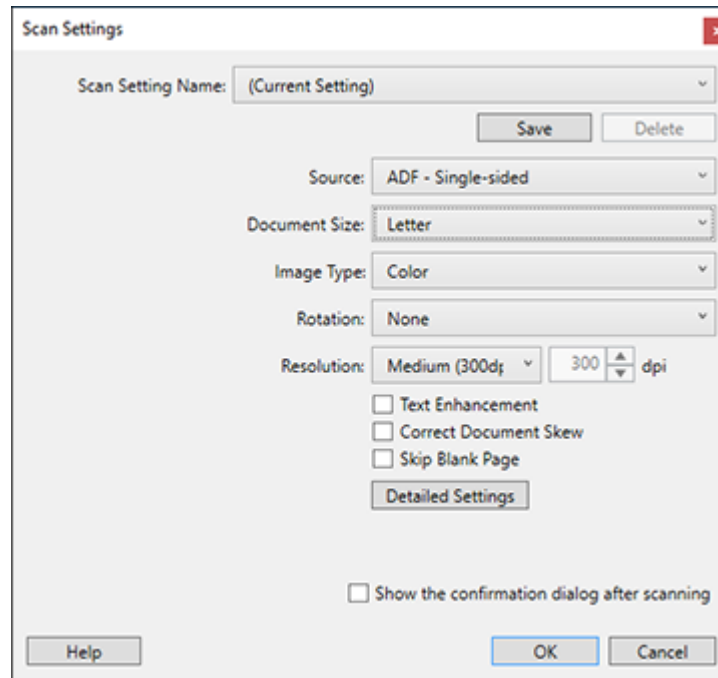

5. Select any displayed scan settings you want to use and click **OK**.
6. Click **Scan**.

You see a preview of your scan in the Document Capture Pro window.

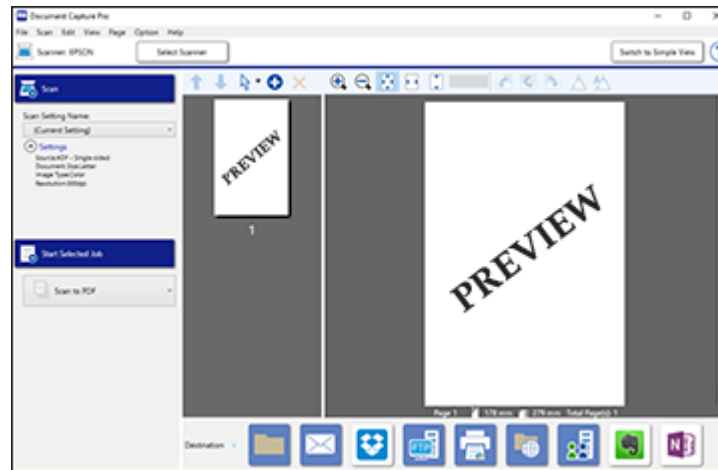

**Note:** You may have to close the Epson Scan 2 window to view your scan in the Document Capture Pro window.

7. If you would like to scan additional originals and add them to the current captured images, click the  Add Page icon and follow the instructions on the screen.
8. Check the scanned images and edit them as necessary.
9. Click one of the Destination icons to choose where to send your scanned files. (If you cannot see all of the icons below, click the arrow next to the icons.)



10. Depending on the destination you chose, click **OK** or **Send** to complete the scan.

**Parent topic:** [Scanning](#)



## Scanning with Document Capture - Mac

When you scan with Document Capture, the program automatically saves your scanned file on your computer in the folder you specify. You can select settings, preview, and change the scanned file settings as necessary.

**Note:** The settings may vary, depending on the software version you are using. See the Help information in Document Capture for details.

1. Load your original in the product.
2. Open the **Applications** folder, open the **Epson Software** folder, and select **Document Capture**.

You see a window like this:

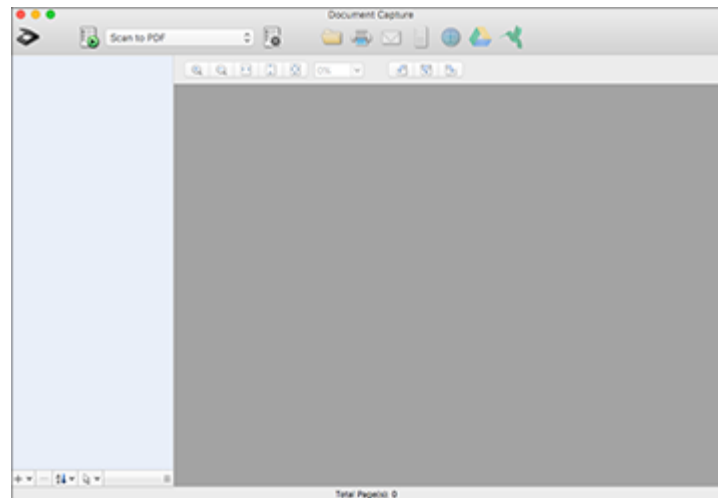

**Note:** You may need to select your scanner from the scanner list.

3. Click the  **Scan** icon.

You see a window like this:

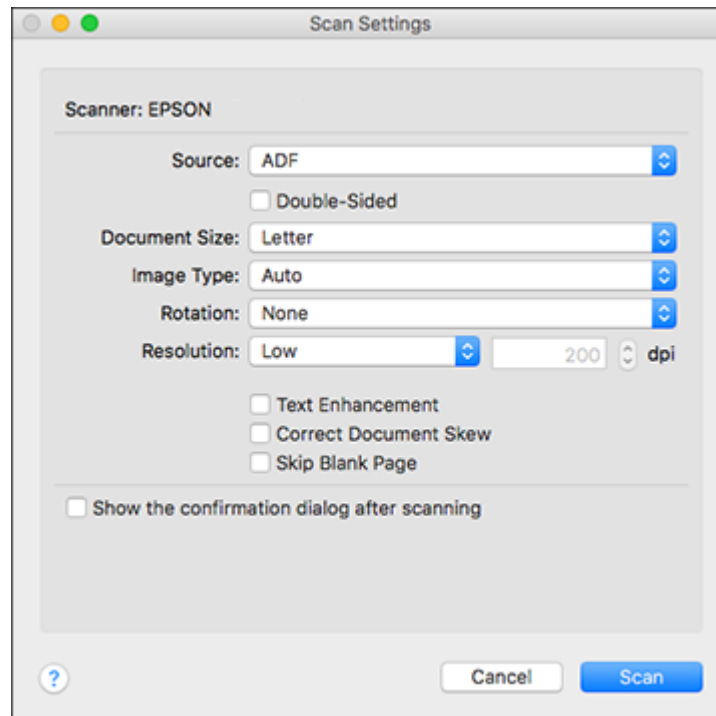

**Note:** If you want to use a scan job that you created instead, select it from the Job list in the Document Capture window, click the  Start Job button, and skip the rest of these steps.

4. Select any displayed scan settings you want to use.

**Note:** See the Help information in Document Capture for details.

5. If you want to select detailed scan settings, close the Scan Settings window, open the **Scan** menu at the top of the Mac desktop, and select **Displays the EPSON Scan Setup Screen**.
6. Click the  Scan icon and select any detailed scan settings you want to use from the Epson Scan 2 window.
7. Click **Scan**.

You see a preview of your scan in the Document Capture window.

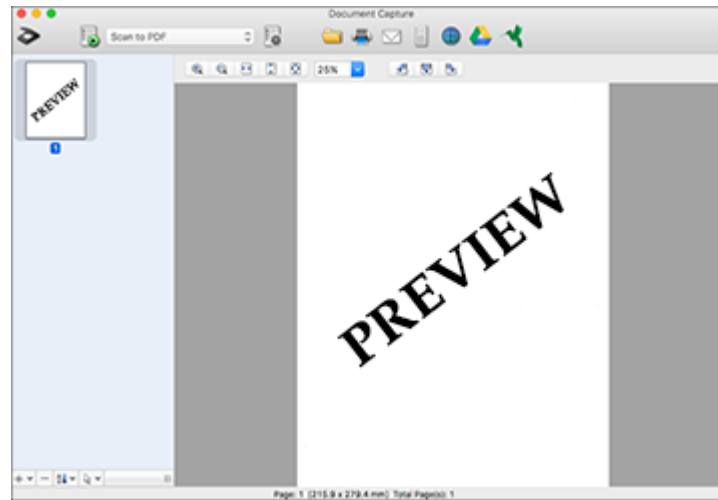

**Note:** You may have to close the Epson Scan 2 window to view your scan in the Document Capture window.

8. If you would like to scan additional originals and add them to the current captured images, click the + icon, select **Acquire from Scanner**, and repeat the previous steps.
9. Check the scanned images and edit them as necessary.
10. Click one of the Destination icons to choose where to send your scanned files. (If you cannot see all of the icons below, click the arrow next to the icons.)



11. Depending on the destination you chose, click **OK** or **Send** to complete the operation.

**Parent topic:** [Scanning](#)

## Scanning in Epson Scan 2

Epson Scan 2 gives you access to basic and advanced scanning features. You can scan your document and save the scanned image in various file formats in your operating system's Documents or My Documents folder, or open it in your scanning program. You can preview the scanned image and select or change settings as necessary.

1. Load your original in the product.
2. Start Epson Scan 2.

You see this window:

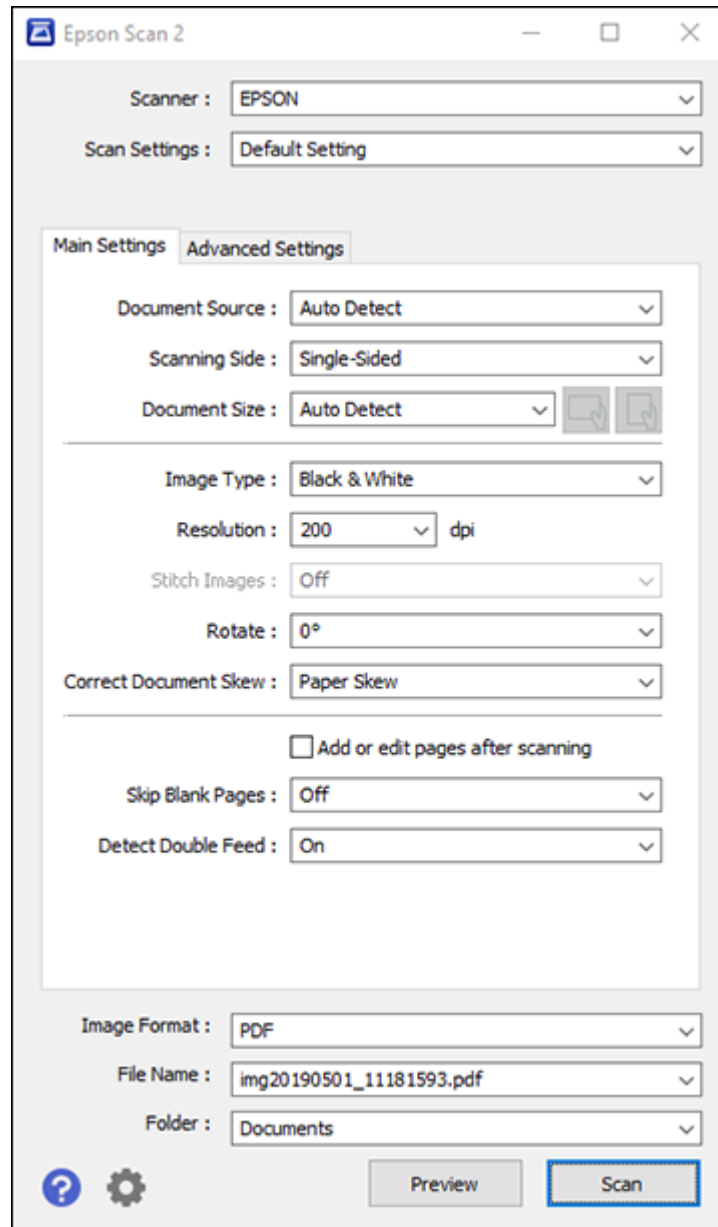

3. Select the **Document Source** setting that matches where you placed your originals, or select **Auto Detect** to have Epson Scan 2 automatically detect the location.
4. Select the **Document Size** setting that matches the size of your original, or select **Auto Detect** to have Epson Scan 2 automatically detect the size. You can select **Customize** to enter a custom size, if necessary.
5. Click on one of the orientation icons, if applicable.
6. Select your original image type and how you want it scanned as the **Image Type** setting, or select **Auto** to have Epson Scan 2 automatically detect the image type.
7. Select the **Resolution** setting you want to use for your scan.
8. Select any of the additional settings that you want to use on the **Main Settings** tab.
9. Click the **Advanced Settings** tab and select any settings that you want to use.
10. To see a preview of your scan with the settings you selected, click the **Preview** button.

Epson Scan 2 previews your original and displays the results in the Epson Scan 2 window.

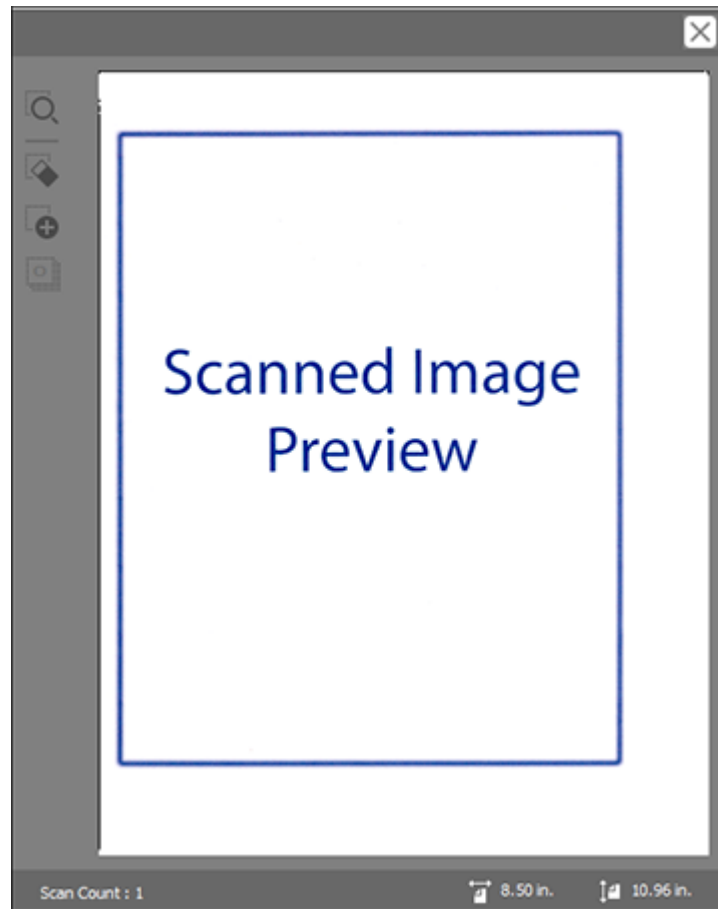

**Note:** If your originals were scanned from the ADF, reload your originals.

11. Select the format in which you want to save your scanned file as the **Image Format** setting. If necessary, select **Options** and select any desired format options.
12. Select **Settings** to modify the file name settings. Enter the file name for your scanned file in the **File Name** field.

13. Select the location in which you want to save your scanned file as the **Folder** setting. If necessary, select **Select** to choose an alternate folder or create a new folder.
14. Click **Scan**.

The product scans your original and saves the scanned file in the location you specified.

[Additional Scanning Settings - Main Settings Tab](#)

[Additional Scanning Settings - Advanced Settings Tab](#)

[Image Format Options](#)

**Parent topic:** [Scanning](#)

**Related topics**

[Placing Originals on the Scanner](#)

## Additional Scanning Settings - Main Settings Tab

You can select these additional scanning settings on the Epson Scan 2 Main Settings tab.

### Stitch Images

When scanning double-sided originals, lets you lay out images from both sides of the original onto one scanned page.

### Rotate

Rotates the original image clockwise to the desired angle before scanning it. Select **Auto** to allow your product to automatically rotate the image based on the orientation of the text (may take longer to scan).

### Correct Document Skew

Corrects skewed originals, image contents, or both.

### Add or edit pages after scanning

Lets you add, remove, or edit the pages in a scan, including rotating pages and changing the page order.

**Note:** To save multiple pages in a single file, you must select a file format that supports multiple pages such as **PDF** or **Multi-TIFF**. If you select another file format, each scanned image or page is saved as a separate file.

### Skip Blank Pages

If the scanner detects marks from the other side of a blank page and adds the marks to the scanned image, adjust this setting to prevent this.



**Detect Double Feed**

Detects a double-feed paper error in the ADF. If you are scanning an original envelope or plastic card, select **Off**.

**Parent topic:** [Scanning in Epson Scan 2](#)

## Additional Scanning Settings - Advanced Settings Tab

You can select these additional scanning settings on the Epson Scan 2 Advanced Settings tab. Not all adjustment settings may be available, depending on other settings you have chosen or your scanner's features.

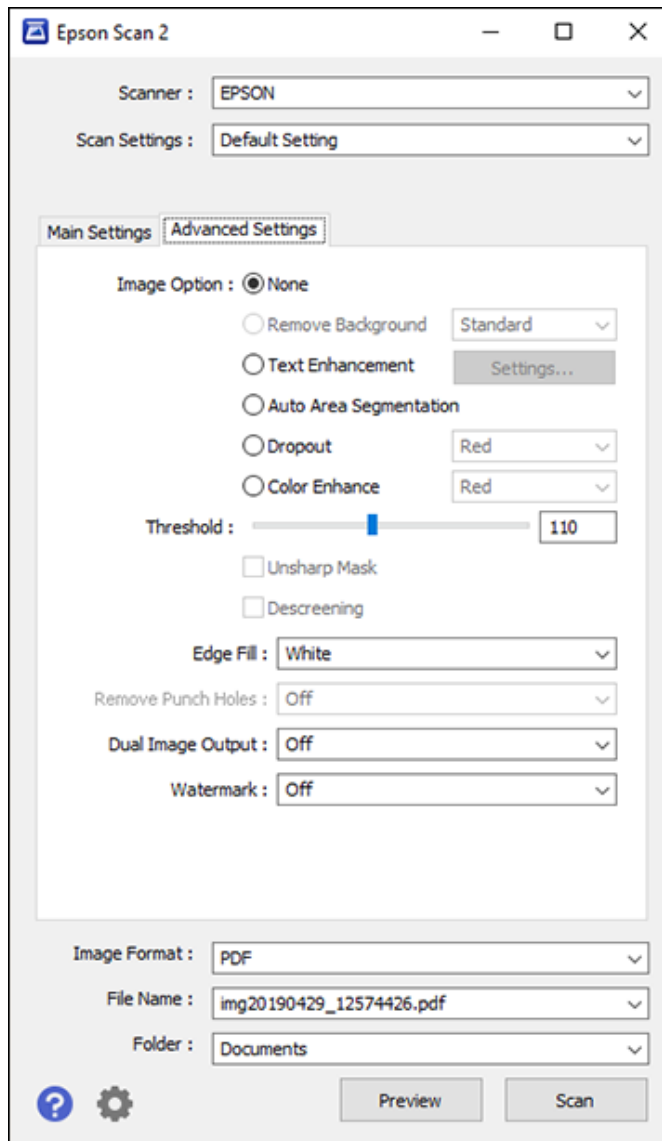

**Remove Background**

Removes the background from your originals.

**Text Enhancement**

Sharpens the appearance of letters in text documents.

**Auto Area Segmentation**

Makes black and white images clearer and text recognition more accurate by separating the text from the graphics.

**Dropout**

The scan will not pick up the color you select. This setting is available only if you select **Grayscale** or **Black & White** as the Image Type setting.

**Color Enhance**

Enhances the shades of the color you select in the scanned image. This setting is available only if you select **Grayscale** or **Black & White** as the Image Type setting.

**Brightness**

Adjusts the overall lightness and darkness of the scanned image.

**Contrast**

Adjusts the difference between the light and dark areas of the overall scanned image.

**Gamma**

Adjusts the midtone density of the scanned image.

**Threshold**

Adjusts the level at which black areas in text and line art are delineated, improving text recognition in OCR (Optical Character Recognition) programs.

**Unsharp Mask**

Makes the edges of certain image areas clearer. Turn off this option to leave softer edges.

**Descreening**

Removes the ripple pattern that might appear in subtly shaded image areas, such as skin tones. This option improves results when scanning magazines or newspapers. (The results of descreening do not appear in the preview image, only in your scanned image.)

**Edge Fill**

Corrects shadowing around the edges of the image by filling the shadows with black or white.

**Remove Punch Holes**

Removes the shadows caused by holes on the edges of the original.

**Dual Image Output**

Scans the original image twice using different output settings (Windows only).

**Watermark**

Adds a watermark to scanned images.

Parent topic: [Scanning in Epson Scan 2](#)

## Image Format Options

You can select different image formats and related options. For details on available options, click the ? icon on the Epson Scan 2 Image Format Options window. Not all image formats have options.

**BITMAP (\*.bmp)**

A standard image file format for most Windows programs.

**JPEG (\*.jpg)**

An image format that lets you highly compress image data. However, the higher the compression, the lower the image quality. (The TIFF format is recommended when you need to modify or retouch your scanned image.)

**PNG (\*.png)**

An image format that does not lose quality during editing.

**TIFF (\*.tif)**

A file format created for exchanging data between many programs, such as graphic and DTP software.

**Multi-TIFF (\*.tif)**

A TIFF file format when multiple pages are saved to the same file, allowing you to edit the images using a compatible program.

**PDF (\*.pdf)**

A document format that is readable by Windows and Mac systems using Adobe Reader, Acrobat, or other programs. You can save multi-page documents in one PDF file.

**Searchable PDF (\*.pdf)**

A document format that is readable by Windows and Mac systems using Adobe Reader, Acrobat, or other programs. You can save multi-page documents in one PDF file. Recognized text in the scanned document can be searched.

Parent topic: [Scanning in Epson Scan 2](#)

## Scan Resolution Guidelines

The **Resolution** setting, measured in dpi (dots per inch), controls the amount of detail captured in your scans. Increasing the resolution raises the amount of detailed captured but comes with the following disadvantages:

- Larger file sizes

- It takes longer to scan your originals, send/receive your scans by email or fax, and to print your scans
- The image may become too large to fit on your display or print on paper

Select a Resolution setting based on how you plan to use the scanned image:

- Email, view on a computer screen, or post on the web: 96 to 150 dpi
- Print, fax, convert to editable text (OCR), or create a text searchable PDF: 200 to 300 dpi

**Note:** If you plan to enlarge a scanned image so you can print it at a larger size, increase the resolution by the same amount you will increase the image size to retain a high image quality. For example, if you normally scan your image in its original size at 300 dpi but plan to double the image size later, change the Resolution setting to 600 dpi. If you are scanning long documents, you may not be able to scan above 300 dpi.

**Parent topic:** [Scanning](#)

## Scanning Special Projects

Your product's scanning software offers various options to help you quickly complete special scan projects.

[Scanning Multi-Page Originals as Separate Files - Windows](#)

[Saving a Scan as an Office Format File - Windows](#)

**Parent topic:** [Scanning](#)

## Scanning Multi-Page Originals as Separate Files - Windows

You can use Document Capture Pro (Windows) to scan multi-page originals as separate scanned files. You indicate how the separate files are created by defining a maximum page count per file or by inserting blank pages, barcodes, or characters that can be detected by the software as separation markers.

**Note:** The settings may vary, depending on the software version you are using. See the help information in Document Capture Pro for details.

1. Load your multi-page original in the product.
2. Do one of the following to start Document Capture Pro:
  - **Windows 10:** Click  and select **Epson Software > Document Capture Pro**.
  - **Windows 8.x:** Navigate to the **Apps** screen and select **Document Capture Pro**.

- **Windows (other versions):** Click  or **Start**, and select **All Programs** or **Programs**. Select **Epson Software > Document Capture Pro**.

You see the Document Capture Pro window.

3. If you see a **Switch to Simple View** button in the upper right corner of the window, click it.

You see a window like this:

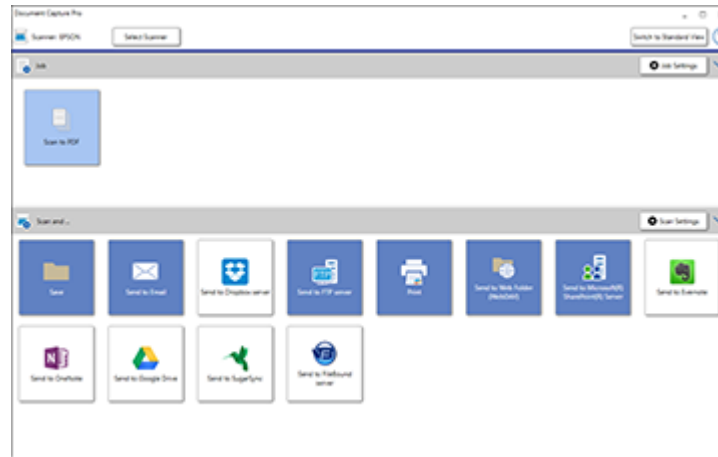

4. Click the **Scan Settings** button.

**Note:** If you do not see any icons, click the **V** symbol next to the **Job Settings** button.

You see a window like this:

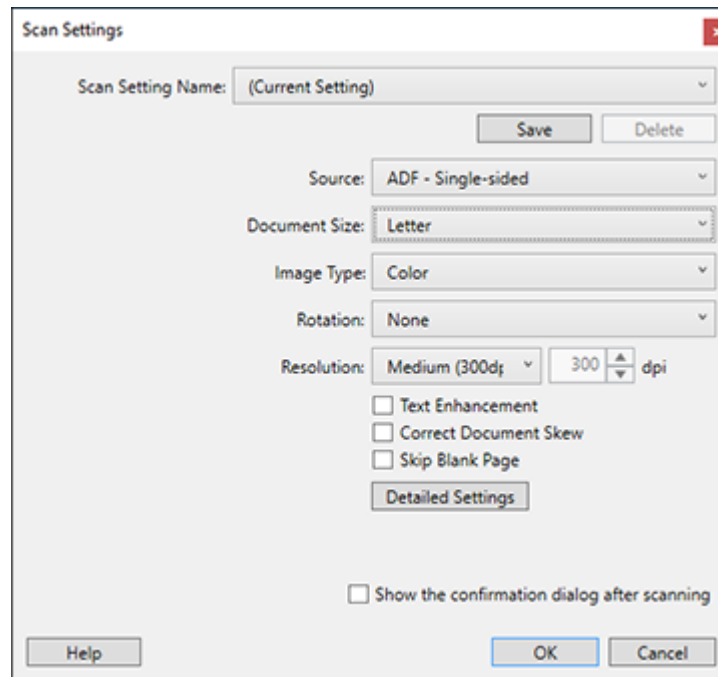

5. Select any displayed settings you want to use and click **OK**.

**Note:** See the help information in Document Capture Pro for details.

6. Click one of the destination icons (except **Print**) in the **Scan and...** section of the window. Your product starts scanning and you see the settings window.
7. Select the **Apply job separation** checkbox.
8. Click **Separation Settings**.

You see a window like this:

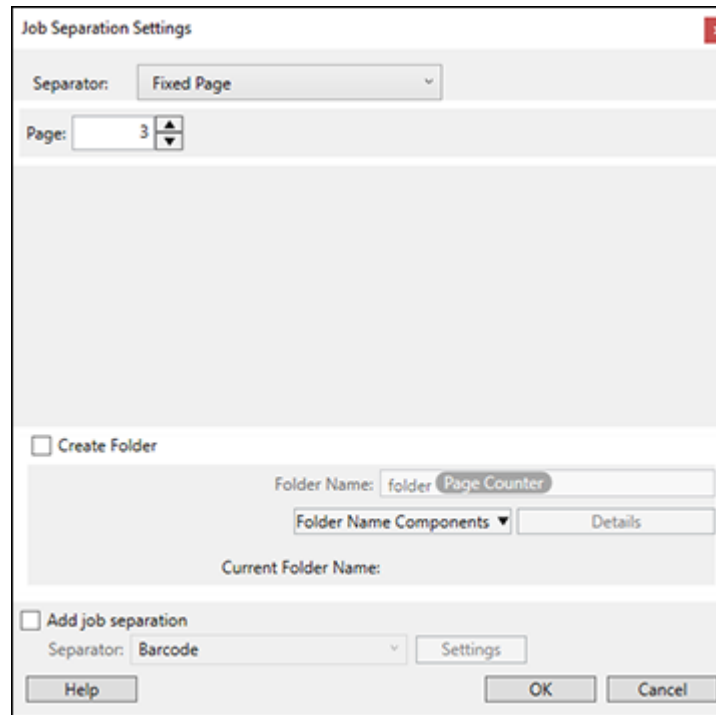

9. Select the method you used to separate the originals as the **Separator** setting.

**Note:** See the help information in Document Capture Pro for details.

10. If necessary, select **Create Folder** and select a folder name.
11. Select any other folder naming settings you want and click **OK**, then click **OK** again.

Your originals are saved into separate files and folders as specified.

**Parent topic:** [Scanning Special Projects](#)

**Related topics**



[Placing Originals on the Scanner](#)



## Saving a Scan as an Office Format File - Windows

You can use Document Capture Pro (Windows) to save your scans in one of the following Microsoft Office file formats: Microsoft Word (.docx), Microsoft Excel (.xlsx), or Microsoft PowerPoint (.pptx).

**Note:** The settings may vary, depending on the software version you are using. See the help information in Document Capture Pro for details.

1. Load your original in the product.
2. Do one of the following to start Document Capture Pro:
  - **Windows 10:** Click  and select **Epson Software > Document Capture Pro**.
  - **Windows 8.x:** Navigate to the **Apps** screen and select **Document Capture Pro**.
  - **Windows (other versions):** Click  or **Start**, and select **All Programs** or **Programs**. Select **Epson Software > Document Capture Pro**.
3. If you see a **Switch to Simple View** button in the upper right corner of the window, click it.  
You see a window like this:

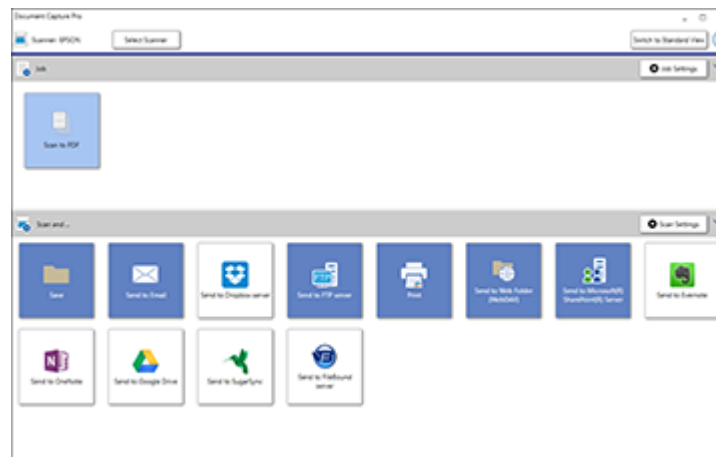

4. Click the **Scan Settings** button.

**Note:** If you do not see any icons, click the **V** symbol next to the **Job Settings** button.

You see a window like this:

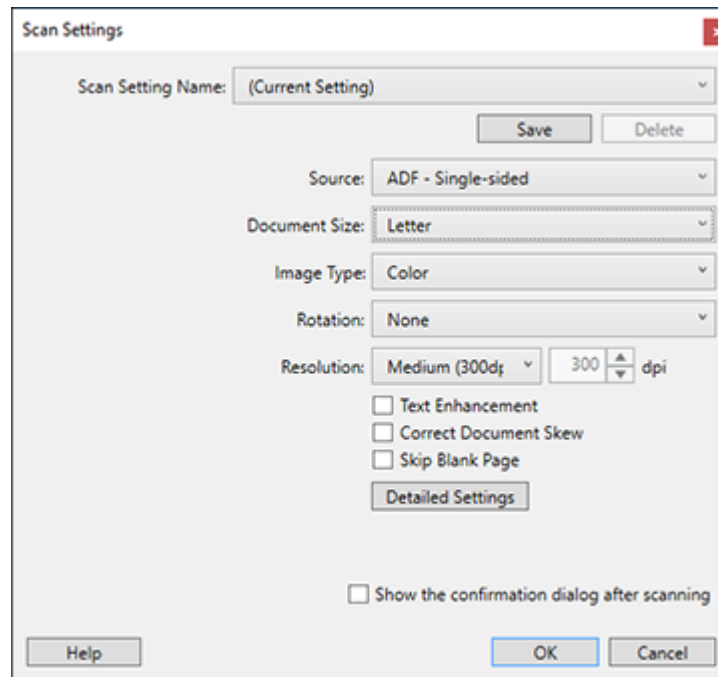

5. Select any displayed settings you want to use and click **OK**.

**Note:** See the help information in Document Capture Pro for details.

6. Click one of the destination icons (except **Print**) to choose where to send your scanned files. Your product starts scanning and you see the settings window.
7. Select the Office format file you want to use from the **File Type** drop-down list.

**Note:** The first time you select an Office format file you are prompted to download a plug-in update for Microsoft Office files. Select **Yes** to download and install the plug-in.

8. Click **Option** to display additional settings.

9. Select any additional settings as necessary and click **OK**.

**Note:** See the help information in Document Capture Pro for details.

10. Confirm your settings and click **OK**.

Your originals are saved in the Office file format you selected.

**Parent topic:** [Scanning Special Projects](#)

**Related topics**

[Placing Originals on the Scanner](#)

---

# Cleaning and Transporting Your Scanner

See these sections if you need to clean or transport your scanner.

[Cleaning Your Scanner](#)

[Checking the Scanner Roller Counter](#)

[Replacing the Scanner Rollers](#)

[Transporting Your Scanner](#)

## Cleaning Your Scanner

To keep your product working at its best, you should clean it several times a year.

**Caution:** Do not use a hard brush, alcohol, or paint thinner to clean the product or you may damage it. Do not use oil or other lubricants inside the product or let water get inside it. Do not open the product case. Do not press the surface of the scanner glass with any force and be careful not to scratch or damage the scanner glass. A damaged glass surface can decrease the scan quality.

1. Turn off the scanner.
2. Unplug the AC adapter.
3. Disconnect the USB cable.
4. Clean the outer case with a cloth dampened with mild detergent and water.

5. If the scanner glass gets dirty, clean it with a soft, dry cloth. If the glass surface is stained with grease or some other hard-to-remove material, use a small amount of glass cleaner on a soft cloth to remove it. Wipe off all remaining liquid.

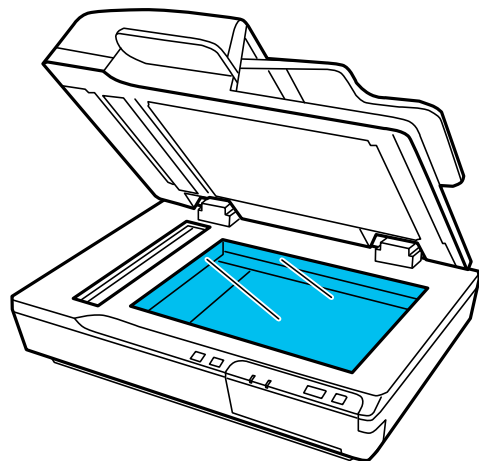

**Note:** Do not spray glass cleaner directly on the scanner glass.

6. Clean the glass areas shown using the Epson cleaning kit.

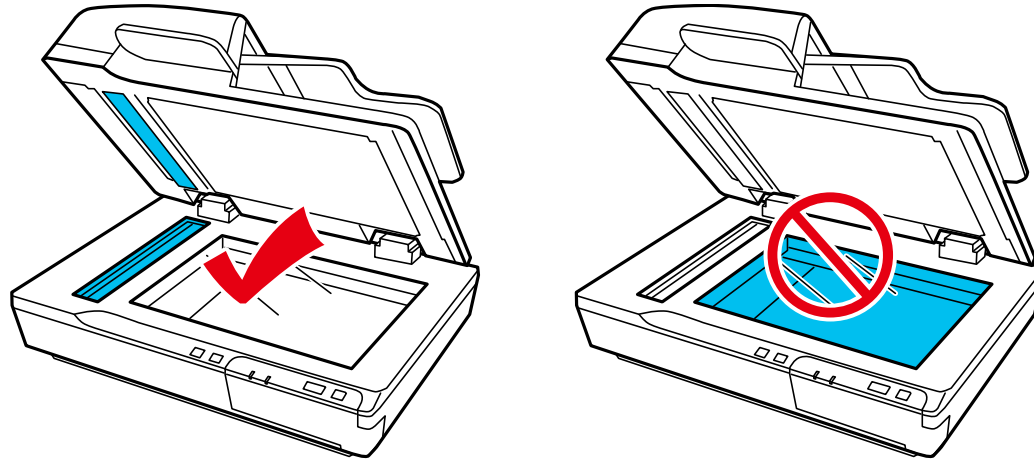

**Note:** Do not use the Epson cleaning kit to clean the document glass.

7. Clean the document mat in the same manner as the scanner glass.

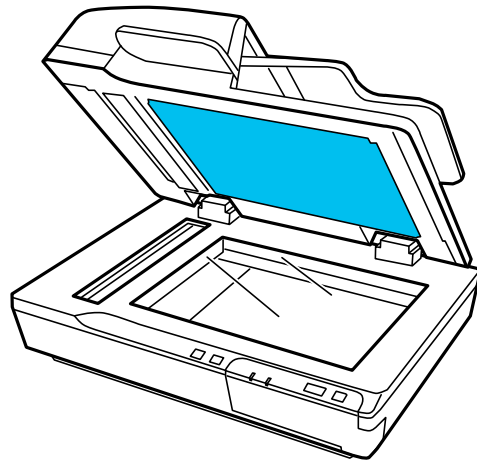

**Note:** Do not let dust build up on the scanner glass or document mat. Dust on the scanner glass can cause spots in your scanned images. Dust on the smaller glass can cause lines and streaks in your scanned images.

8. Open the ADF cover and use a soft, dry cloth to clean the interior of the ADF and the rollers shown here.

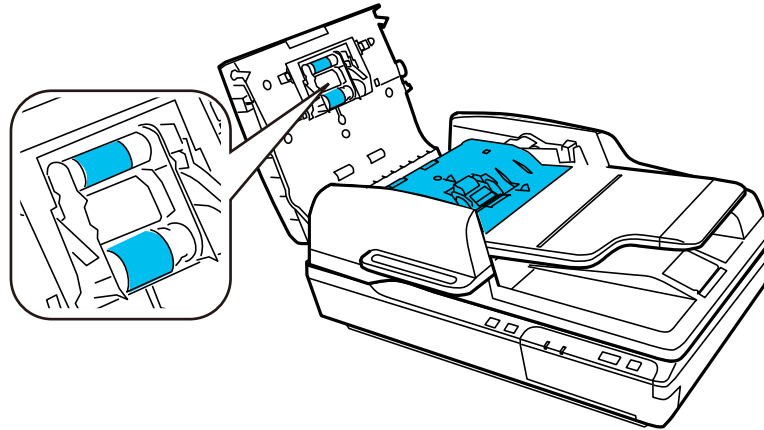

**Caution:** The rollers only turn in one direction. Do not force the rollers to turn in the wrong direction or you may damage your scanner.

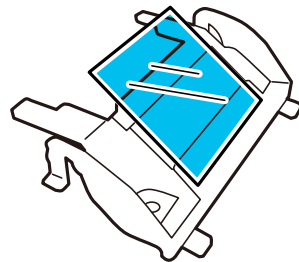



**Caution:** Do not touch the separation pad inside the ADF cover or you may damage your scanner.

**Parent topic:** [Cleaning and Transporting Your Scanner](#)

## Checking the Scanner Roller Counter

Check the scanner roller counter to determine when your rollers need to be replaced. When you replace the scanner rollers, reset the scanner roller counter so you know when you may need to replace the rollers again.

1. Make sure the scanner is turned on and connected to your computer.
2. Do one of the following to open the Epson Scan 2 Utility:
  - **Windows 10:** Click  and select **EPSON > Epson Scan 2 Utility**.
  - **Windows 8.x:** Navigate to the **Apps** screen and select **Epson Scan 2 Utility**.
  - **Windows (other versions):** Click  or **Start > All Programs** or **Programs > EPSON > Epson Scan 2 > Epson Scan 2 Utility**.
  - **Mac:** Open the **Applications** folder, click **Epson Software**, and click **Epson Scan 2 Utility**.
3. Click the **Counter** tab.
4. If the number in the **Number of Scans** field exceeds the number displayed as the **Life Cycle** of the rollers, it is time to replace the rollers.
5. Close the Epson Scan 2 Utility.

**Parent topic:** [Cleaning and Transporting Your Scanner](#)

## Replacing the Scanner Rollers

Check the scanner roller counter to see when you need to replace the rollers.

1. Turn off the scanner.
2. Unplug the AC adapter.
3. Disconnect any connected cables.
4. Remove any loaded originals from the scanner.



5. Open the ADF cover.

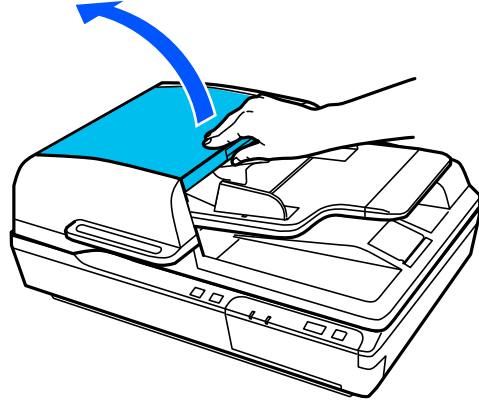

6. Press in the hooks on the sides of the pickup roller cover and flip down the cover.

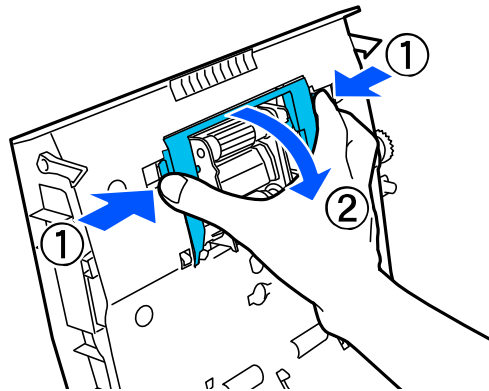

7. Slide the pickup roller to the left, flip it down, and pull it out to remove it.

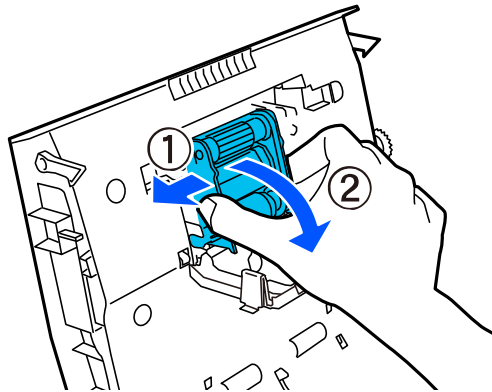

8. To install the new pickup roller, align the tab on the roller with the notch in the scanner as shown. Then slide it to the right.

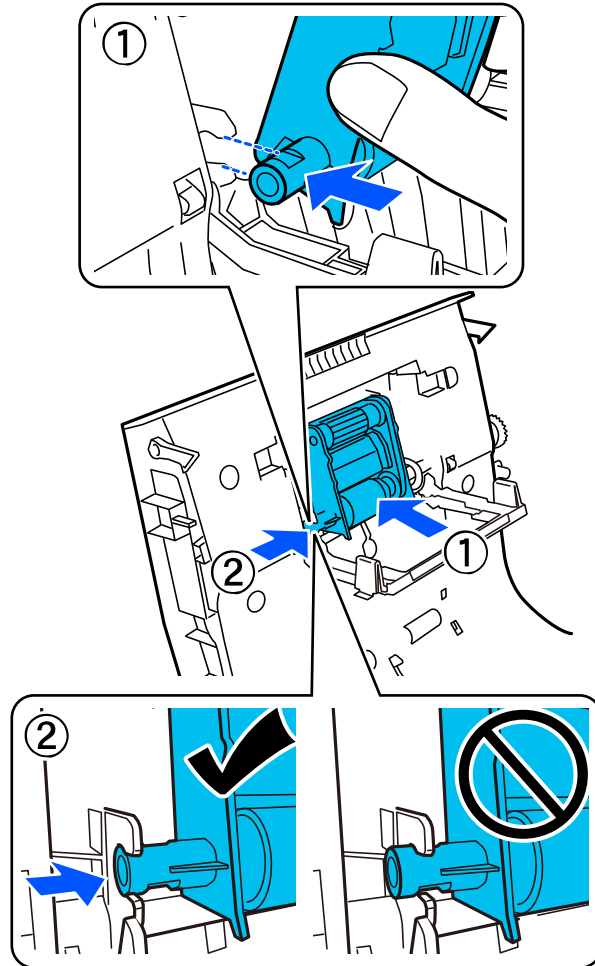

**Note:** Do not touch the surface of the pickup rollers.

9. Close the pickup roller cover.

10. Press in the hooks on the sides of the separation pad cover and remove the cover.

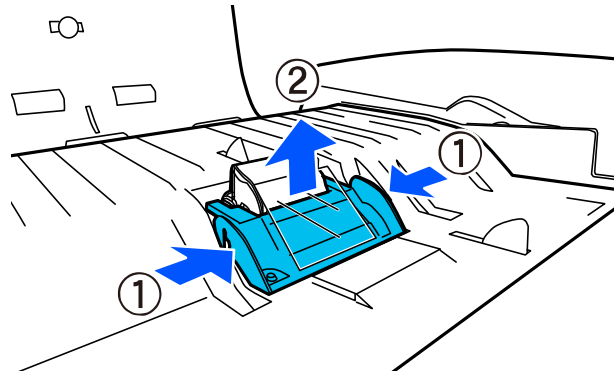

11. Press in the hooks on the sides of the separation pad and pull it up to remove it.

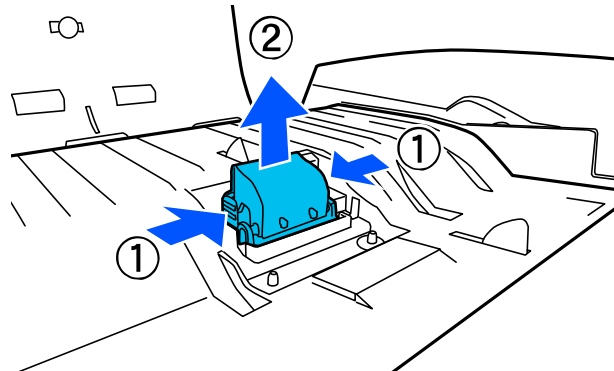

12. Insert the replacement separation pad as shown below and press it down until it clicks into place.

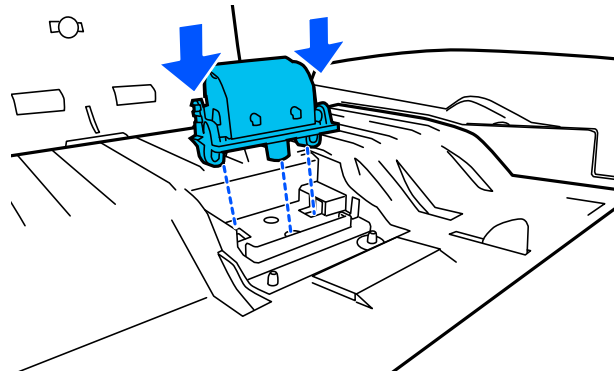

**Note:** Do not touch the surface of the separation pad.

13. Slide the separation pad cover into place and press it down as shown.

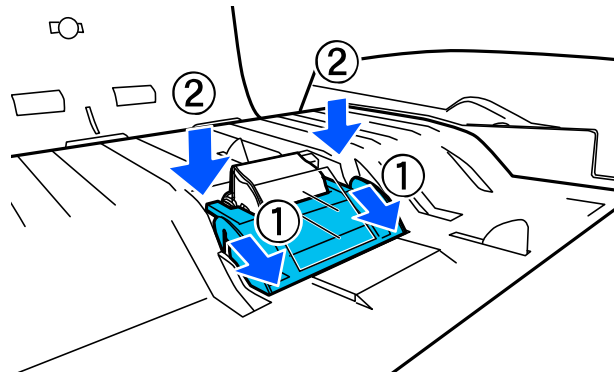

14. Close the ADF cover.

15. Plug in the AC adapter and turn on the scanner.

16. Reset the roller counter after replacing the rollers.



Dispose of the used pickup rollers and separation pad following the regulations in your local area. Do not disassemble the rollers or pad.

## [Resetting the Scanner Roller Counter](#)

**Parent topic:** [Cleaning and Transporting Your Scanner](#)

### **Resetting the Scanner Roller Counter**

When you replace the scanner rollers, reset the scanner roller counter so you know when you may need to replace the rollers again.

1. Make sure the scanner is turned on and connected to your computer.
2. Do one of the following to open the Epson Scan 2 Utility:
  - **Windows 10:** Click  and select **EPSON > Epson Scan 2 Utility**.
  - **Windows 8.x:** Navigate to the **Apps** screen and select **Epson Scan 2 Utility**.
  - **Windows (other versions):** Click  or **Start > All Programs** or **Programs > EPSON > Epson Scan 2 > Epson Scan 2 Utility**.
  - **Mac:** Open the **Applications** folder, click **Epson Software**, and click **Epson Scan 2 Utility**.
3. Click the **Counter** tab.
4. Click **Reset**.

The Number of Scans field changes to 0 (zero).
5. Close the Epson Scan 2 Utility.

**Parent topic:** [Replacing the Scanner Rollers](#)

### **Transporting Your Scanner**

If you need to ship your product, transport it a long distance, or store it for an extended period, prepare it for transportation as described here.

1. Make sure the carriage is in the home position on the left side of the scanner. If the carriage is not in the home position, turn on the scanner and wait until the carriage moves to the home position.
2. Remove any originals from the scanner.
3. Turn off the scanner.
4. Unplug the AC adapter.
5. Disconnect any interface cables.

6. On the side of the scanner, slide the transportation lock to the locked position to secure the scanner carriage.

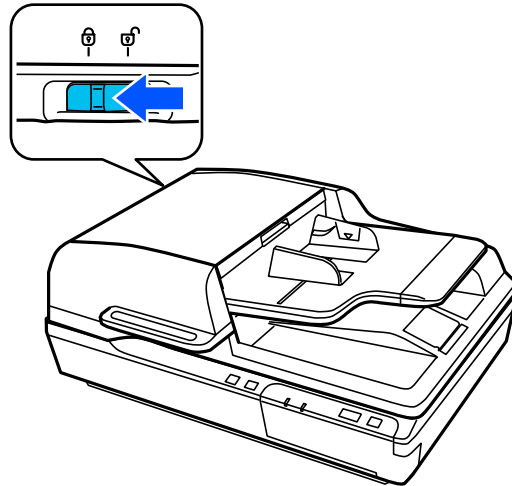

7. Place the scanner in its original packing materials if possible, or use equivalent materials with cushioning around the scanner.

**Parent topic:** [Cleaning and Transporting Your Scanner](#)

---

# Solving Problems

Check these sections for solutions to problems you may have using your product.

[Scanner Light Status](#)

[Solving Scanning Problems](#)

[Solving Original Document Feeding Problems](#)

[Solving Scanned Image Quality Problems](#)



[Uninstall Your Scanner Software](#)

[Where to Get Help](#)

## Scanner Light Status

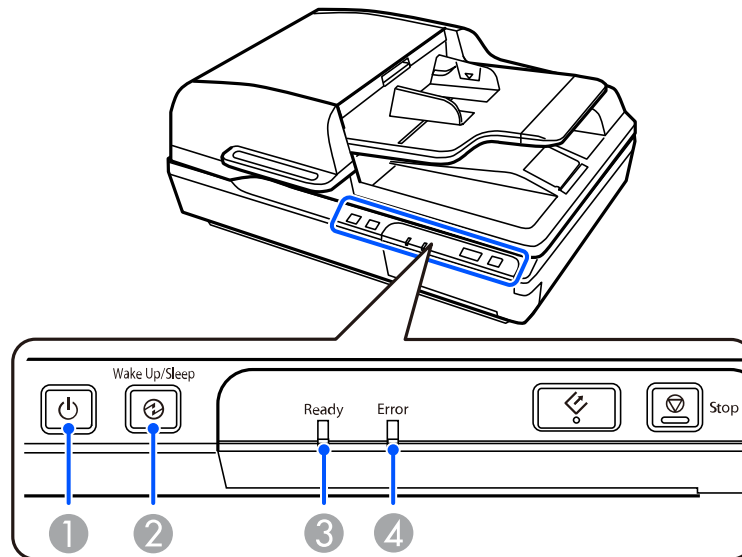
You can often diagnose problems with your scanner by checking its lights.



- 1  power light
- 2  **Wake Up/Sleep** light
- 3 **Ready** light



## 4 Error light

Light status	Condition/solution
Ready light is on	Ready to scan
Ready light is flashing	Initializing or scanning
Ready and Error lights are flashing	Updating firmware
Error light is on	An error has occurred. Turn the scanner off and then back on again. If the error continues, contact Epson for support.
Error light is flashing	The firmware update has failed and the scanner is in recovery mode. Try updating the firmware again. If the error continues, contact Epson for support.
⌚ Wake Up/Sleep light is on	The scanner is in sleep mode; press the ⌚ Wake Up/Sleep button to wake it up
All lights are off	The scanner is turned off

Parent topic: [Solving Problems](#)

Related references

[Where to Get Help](#)

## Solving Scanning Problems

Check these solutions if you have problems scanning with your product.

[Scanner Does Not Turn On or Turns Off Unexpectedly](#)

[Start Button Does Not Work as Expected](#)

[Scanning Software Does Not Operate Correctly](#)

[Cannot Start Epson Scan 2](#)

[Scanning is Slow](#)

Parent topic: [Solving Problems](#)

## Scanner Does Not Turn On or Turns Off Unexpectedly

If the scanner does not turn on or if it turns off unexpectedly, try these solutions:

- Make sure the AC adapter is securely connected to the scanner and to a working electrical outlet.
- If the scanner turns off unexpectedly, you may need to adjust the **Power Off Timer** setting in the Epson Scan 2 Utility.

**Parent topic:** [Solving Scanning Problems](#)

### Related tasks

[Changing the Power Off Setting](#)

## Start Button Does Not Work as Expected

If the  start button does not start the correct program or perform the correct action, try these solutions:

- Make sure the scanner is securely connected to your computer.
- Make sure Epson Scan 2 is installed correctly.
- Make sure Document Capture Pro (Windows) or Document Capture (Mac) is installed correctly.

**Parent topic:** [Solving Scanning Problems](#)

### Related tasks

[Adding and Assigning Scan Jobs with Document Capture Pro - Windows](#)

[Adding and Assigning Scan Jobs with Document Capture - Mac](#)

## Scanning Software Does Not Operate Correctly

If your scanning software does not operate correctly, try these solutions:

- Make sure your computer has adequate memory and meets the system requirements for your operating system.
- Make sure your computer is not running in a power-saving mode, such as sleep or standby. If so, wake your system and restart your scanning software.
- Make sure the scanner is turned on.
- Make sure the connection between the scanner and your computer is secure.
- If you upgraded your operating system but did not reinstall your scanning software, try reinstalling it.
- In Windows, be sure that the scanner is listed under **Imaging Devices** in the Device Manager.

**Note:** The scanner does not appear and the USB port is disabled if the optional Epson Network Scan Module is installed.

- Make sure the scanning software is installed.
- Connect the scanner directly to the computer. The scanner may not work properly when connected through a USB hub.
- Document Capture Pro (Windows) does not support Windows Vista or Windows server, so use Epson Scan 2 for scanning instead.
- If you are using a TWAIN-compliant program, make sure that the correct product is selected as the **Scanner** or **Source** setting.
- If you are using the scanner with the optional Epson Network Scan Module, make sure the network cable is securely connected.

**Parent topic:** [Solving Scanning Problems](#)

**Related references**

[Windows System Requirements](#)

[Mac System Requirements](#)

## Cannot Start Epson Scan 2

If you cannot start Epson Scan 2, try these solutions:

- Make sure your scanner appears in the Epson Scan 2 Utility.
- Restart your computer.
- Make sure your scanner is turned on and any interface cables are securely connected at both ends.
- Make sure your computer is not running in a power-saving mode, such as sleep or standby. If so, wake your system and restart Epson Scan 2.
- Connect the scanner directly to the computer. The scanner may not work properly when connected through a USB hub.
- If you are using the scanner with the optional Epson Network Scan Module, make sure the network cable is securely connected.

**Note:** The USB port is disabled if the optional Epson Network Scan Module is installed.

- If you upgraded your operating system but did not reinstall Epson Scan 2, try reinstalling it.

- If you are using a TWAIN-compliant program, make sure that the correct product is selected as the **Scanner** or **Source** setting.
- Make sure the **Ready** light stops flashing, indicating that the scanner is ready to scan.

**Parent topic:** [Solving Scanning Problems](#)

## Scanning is Slow

If scanning becomes slow, try these solutions:

- Scan your original at a lower resolution, if possible.
- Make sure your system meets the requirements for your operating system. If you are scanning a high-resolution image, you may need more than the minimum requirements. If necessary, increase your system's memory or reduce the resolution.

**Parent topic:** [Solving Scanning Problems](#)

### Related references

[Windows System Requirements](#)

[Mac System Requirements](#)

## Solving Original Document Feeding Problems

Check these solutions if you have problems feeding originals through your product.

[Originals Do Not Feed From the Automatic Document Feeder](#)

[Original Jams in Scanner ADF](#)

**Parent topic:** [Solving Problems](#)

## Originals Do Not Feed From the Automatic Document Feeder

If your originals do not feed when placed in the ADF, try these solutions:

- Make sure the size, weight, and number of your originals are supported by the ADF.
- Make sure the originals are loaded correctly.
- Make sure the document is not curled or creased.
- Try cleaning the inside of the ADF.
- Do not load originals above the arrow mark on the ADF edge guide.

**Parent topic:** [Solving Original Document Feeding Problems](#)

**Related references**

[Original Document Specifications for the ADF](#)

**Related tasks**

[Placing Originals in the ADF](#)

[Cleaning Your Scanner](#)

**Original Jams in Scanner ADF**

If an original has jammed inside the scanner's automatic document feeder, follow these steps:

1. Turn off your scanner.
2. Remove all originals from the ADF.
3. Open the ADF cover.

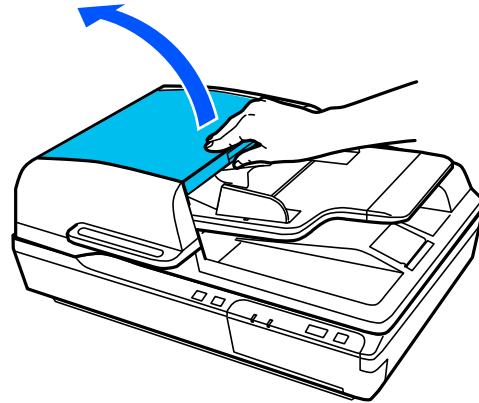

4. Lift up the ADF input tray and turn the dial in the direction shown while slowly removing the jammed original from beneath the input tray.

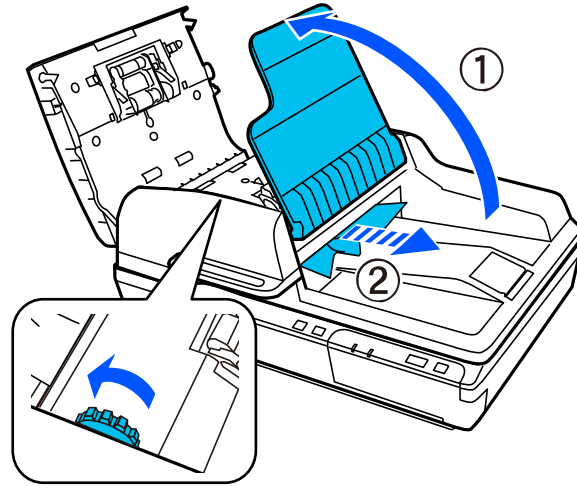

**Caution:** Remove the originals carefully or you may damage the original or your scanner.

5. To remove any other jammed originals, lower the ADF input tray and turn the dial in the direction shown while slowly removing the jammed original from beneath the ADF cover.

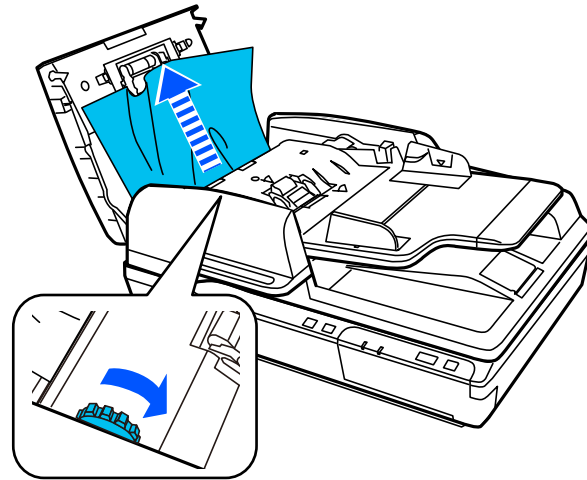

6. Close the ADF cover.

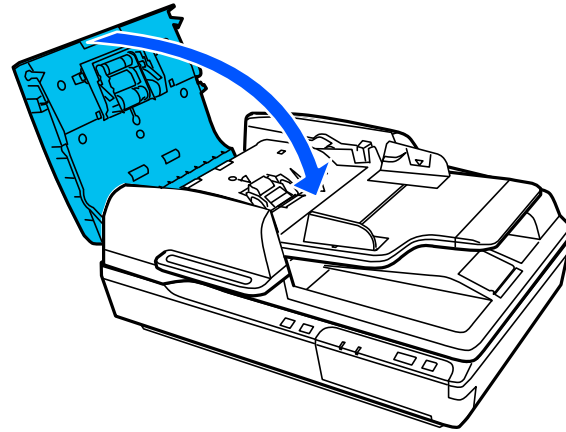

7. Carefully follow all loading instructions when you reload originals and keep your scanner clean to avoid jammed originals.

**Parent topic:** [Solving Original Document Feeding Problems](#)

**Related tasks**

[Placing Originals in the ADF](#)

[Cleaning Your Scanner](#)

## Solving Scanned Image Quality Problems

Check these sections if a scanned image on your computer screen has a quality problem.

[Scanned Image Quality Problems](#)

[Image Consists of a Few Dots Only](#)

[Line of Dots Appears in All Scanned Images](#)

[Straight Lines in an Image Appear Crooked](#)

[Image Colors are Patchy at the Edges](#)

[Binding Margins on a Scanned Booklet are Blurry](#)

[Ripple Patterns Appear in an Image](#)

[Scanned Image Edges are Cropped](#)

[Characters are not Recognized During Conversion to Editable Text \(OCR\)](#)

[Resetting the Epson Scan 2 Settings](#)

Parent topic: [Solving Problems](#)

## Scanned Image Quality Problems

If you encounter quality problems with your scanned image, try these solutions:

### Image is Distorted or Blurry

- Make sure your original is not wrinkled or warped. This may prevent the original from laying flat on the scanner glass.
- Do not move your original or your product during scanning.
- Your product will not operate properly while tilted at an angle. Place your product on a flat, stable surface that extends beyond its base in all directions.
- Adjust these Epson Scan 2 settings (if available) and try scanning again:
  - Increase the **Resolution** setting.
  - If the **Image Type** setting is **Black & White**, adjust the **Threshold** setting.
  - If the **Image Type** setting is **Color** or **Grayscale**, select the **Unsharp Mask** setting.
  - If the **Image Type** setting is **Black & White**, select **Text Enhancement**. If the **Image Type** setting is **Color** or **Grayscale**, change the **Text Enhancement** setting to **High**.

### Image is Too Dark

- If the **Image Type** is set to **Color** or **Grayscale**, adjust the **Brightness** setting.
- Check the brightness and contrast settings of your computer monitor.

### Back of Original Image Appears in Scanned Image

- Place a piece of black paper on the back of the original and scan it again.
- Adjust these Epson Scan 2 settings (if available) and try scanning again:
  - Select the **Advanced Settings** tab and adjust the **Brightness** setting.
  - Select **Text Enhancement**.

### Scanned Image Colors Do Not Match Original Colors

Printed colors can never exactly match the colors on your computer monitor because printers and monitors use different color systems: monitors use RGB (red, green, and blue) and printers typically use CMYK (cyan, magenta, yellow, and black).



Check the color matching and color management capabilities of your computer, display adapter, and the software you are using to see if they are affecting the palette of colors you see on your screen.

To adjust the colors in your scanned image, adjust these Epson Scan 2 settings (if available) and try scanning again:

- If the **Image Type** setting is **Color** or **Grayscale**, adjust the **Contrast** setting.
- If the **Image Type** setting is **Black & White** or **Grayscale**, adjust the **Color Enhance** setting.

**Parent topic:** [Solving Scanned Image Quality Problems](#)

#### **Related tasks**

[Scanning in Epson Scan 2](#)

## **Image Consists of a Few Dots Only**

If your scanned image consists only of a few dots, try these solutions:

- Make sure you placed your original for scanning facing the correct way.
- If the **Image Type** setting is **Black & White**, adjust the **Threshold** and scan again.
- Do not press on the original or the document cover with too much force.

**Parent topic:** [Solving Scanned Image Quality Problems](#)

#### **Related tasks**

[Scanning in Epson Scan 2](#)

#### **Related topics**

[Placing Originals on the Scanner](#)

## **Line of Dots Appears in All Scanned Images**

If a line of dots appears in all your scanned images, try these solutions:

- Clean the scanner glass with a soft, dry, lint-free cloth or use a small amount of glass cleaner on the cloth, if necessary. Paper towels are not recommended.

**Caution:** Do not spray glass cleaner directly on the scanner glass.

- Make sure any interface cables are securely connected at both ends.

If you are scanning from the ADF, make sure the ADF edge guides fit against the loaded originals. You can also try cleaning the ADF and scanning again.

**Parent topic:** [Solving Scanned Image Quality Problems](#)

**Related tasks**

[Cleaning Your Scanner](#)

**Straight Lines in an Image Appear Crooked**

If straight lines in an original appear crooked in a scanned image, make sure to place your original straight when you scan it.

If you are scanning from the ADF, make sure the ADF edge guides fit against the loaded originals. You can also try cleaning the ADF and scanning again.

**Parent topic:** [Solving Scanned Image Quality Problems](#)

**Related tasks**

[Cleaning Your Scanner](#)

**Related topics**

[Placing Originals on the Scanner](#)

**Image Colors are Patchy at the Edges**

If you are scanning a thick or warped original, cover its edges with paper to block external light as you scan it.

**Parent topic:** [Solving Scanned Image Quality Problems](#)

**Binding Margins on a Scanned Booklet are Blurry**

When scanning a booklet on the scanner glass, characters may appear distorted or blurred on the binding margin. If this occurs, the characters may not be recognized correctly when you save the scanned image as a searchable PDF.

To decrease distortion or blurring, gently press down on the document cover to flatten the booklet while scanning.

**Caution:** Do not press down on the document cover with too much force, or you may damage the booklet or scanner.

**Parent topic:** [Solving Scanned Image Quality Problems](#)

**Related tasks**

[Placing Originals on the Scanner Glass](#)

## Ripple Patterns Appear in an Image

You may see a ripple pattern (called a moiré) in scanned images of printed documents. This is caused by interference from differing pitches in the scanner's screen and your original's halftone screen. To reduce this effect, adjust these Epson Scan 2 settings (if available) and try scanning again:

- Select the **Descreening** setting.
- Select a lower **Resolution** setting.

**Parent topic:** [Solving Scanned Image Quality Problems](#)

### Related tasks

[Scanning in Epson Scan 2](#)

## Scanned Image Edges are Cropped

If the edges of a scanned image are cropped, make sure your original is placed correctly for scanning. If necessary, move your original away from the edges of the scanner glass slightly.

**Parent topic:** [Solving Scanned Image Quality Problems](#)

### Related tasks

[Placing Originals on the Scanner Glass](#)

## Characters are not Recognized During Conversion to Editable Text (OCR)

If characters in your scanned images are not recognized during OCR conversion, try these solutions:

- Make sure your original is loaded straight on your product.
- Use an original with clear text.
- Adjust these Epson Scan 2 settings (if available) and try scanning again:
  - Select the correct **Image Type** setting.
  - Select or adjust the **Text Enhancement** setting.
  - If the **Image Type** is set to **Black & White**, adjust the **Threshold** setting.
  - Set the **Image Type** to **Grayscale**.
- Set the scanning resolution between 200 and 600 dpi.
- If the original document is in landscape mode, set the **Rotate** setting to **Auto** in Epson Scan 2.
- If you are using OCR software, check the manual for any additional adjustments.
- Scan thermal paper receipts as soon as possible. They may deteriorate due to age or friction.

- When saving to Microsoft Office or Searchable PDF files, check that the correct languages are selected. Check the language in each save setting window.
- Some font types may cause recognition errors. If the original font cannot be changed, you may need to manually edit the unrecognized text.

**Parent topic:** [Solving Scanned Image Quality Problems](#)

**Related tasks**



[Scanning in Epson Scan 2](#)

**Related topics**

[Placing Originals on the Scanner](#)

## Resetting the Epson Scan 2 Settings

If you continue to experience image quality problems after trying all possible solutions, you may need to reset the Epson Scan 2 settings using the Epson Scan 2 Utility.

1. Do one of the following to start the Epson Scan 2 Utility:
  - **Windows 10:** Click  > **EPSON** > **Epson Scan 2 Utility**.
  - **Windows 8.x:** Navigate to the **Apps** screen and select **Epson Scan 2 Utility**.
  - **Windows (other versions):** Click  or **Start**, and select **All Programs** or **Programs**. Select **EPSON** > **Epson Scan 2** > **Epson Scan 2 Utility**.
  - **Mac:** Open the **Applications** folder, open the **Epson Software** folder, and select **Epson Scan 2 Utility**.
2. Click the **Other** tab.
3. Click **Reset**.

**Note:** If resetting the Epson Scan 2 settings does not solve your problem, uninstall Epson Scan 2 and re-install it.

**Parent topic:** [Solving Scanned Image Quality Problems](#)

**Related concepts**

[Uninstall Your Scanner Software](#)

## Uninstall Your Scanner Software

If you have a problem that requires you to uninstall and re-install your software, follow the instructions for your operating system.



[Uninstalling Scanner Software](#)

[Uninstalling Scanner Software - Mac](#)

**Parent topic:** [Solving Problems](#)

## Uninstalling Scanner Software

You can uninstall and then re-install your scanner software to solve certain problems.

1. Turn off the scanner.
2. Disconnect any interface cables.
3. Do the following to uninstall each of your scanning software programs and follow any on-screen instructions:
  - **Windows 10:** Click  and select  (Settings) > **Apps** > **Apps & features**. Select the scanner software program and right-click **Uninstall**.
  - **Windows 8.x:** Navigate to the **Apps** screen and select **Control Panel** > **Programs** > **Programs and Features**. Select the scanner software program and right-click **Uninstall/Change**.
  - **Windows 7 or Windows Vista:** Open the Windows **Control Panel** utility. Select **Programs and Features**. (In Classic view, select **Programs** and click **Uninstall a program**.) Select the scanner software program and click **Uninstall/Change**.
4. Restart your computer, then see the *Start Here* sheet to re-install your software.

**Note:** If you find that re-installing your scanner software does not solve a problem, contact Epson.

**Parent topic:** [Uninstall Your Scanner Software](#)

## Uninstalling Scanner Software - Mac

In most cases, you do not need to uninstall your scanner software before re-installing it. However, you can download the Uninstaller utility from the Epson support website to uninstall your scanner software as described here.

1. To download the Uninstaller utility, visit [epson.com/support](http://epson.com/support) (U.S.), [epson.ca/support](http://epson.ca/support) (Canada), or [epson.com.jm/support](http://epson.com.jm/support) (Caribbean) and select your product.
2. Follow the instructions on the screen to install the Uninstaller utility.

3. Quit all applications currently running on your Mac.
4. Double-click the **Uninstaller** icon.
5. In the Epson Uninstaller screen, select the checkbox for each software program you want to uninstall.
6. Click **Uninstall**.
7. Follow the on-screen instructions to uninstall the software.
8. To reinstall your scanner software, see the *Start Here* sheet for instructions.

**Note:** If you find that re-installing your scanner software does not solve a problem, contact Epson.

**Parent topic:** [Uninstall Your Scanner Software](#)

## Where to Get Help

If you need to contact Epson for technical support services, use the following support options.

### Internet Support

Visit Epson's support website at [epson.com/support](http://epson.com/support) (U.S.), [epson.ca/support](http://epson.ca/support) (Canada), or [epson.com.jm/support](http://epson.com.jm/support) (Caribbean) and select your product for solutions to common problems with your product. You can download utilities and documentation, get FAQs and troubleshooting advice, or e-mail Epson with your questions.

### Speak to a Support Representative

Before you call Epson for support, please have the following information ready:

- Product name
- Product serial number (located on a label on the product)
- Proof of purchase (such as a store receipt) and date of purchase
- Computer configuration
- Description of the problem

Then call:

- U.S.: (562) 276-4300, 6 AM to 8 PM, Pacific Time, Monday through Friday, and 7 AM to 4 PM, Pacific Time, Saturday
- Canada: (905) 709-3839, 6 AM to 8 PM, Pacific Time, Monday through Friday, and 7 AM to 4 PM, Pacific Time, Saturday

Days and hours of support are subject to change without notice. Toll or long distance charges may apply.

**Note:** For help using any other software on your system, see the documentation for that software for technical support.

### **Purchase Supplies and Accessories**

You can purchase genuine Epson accessories at [epson.com](http://epson.com) (U.S. sales), [epson.ca](http://epson.ca) (Canadian sales), or [epson.com.jm](http://epson.com.jm) (Caribbean sales). You can also purchase accessories from an Epson authorized reseller. To find the nearest one, call 800-GO-EPSON (800-463-7766) in the U.S. or 800-807-7766 in Canada.

**Parent topic:** [Solving Problems](#)

---

# Technical Specifications

These sections list the technical specifications for your scanner.

**Note:** Epson offers a recycling program for end of life Epson products. Please go to [this site](#) (U.S) or [this site](#) (Canada) for information on how to return your Epson products for proper disposal.

[Windows System Requirements](#)

[Mac System Requirements](#)

[General Specifications](#)

[Dimension Specifications](#)

[Electrical Specifications](#)

[Environmental Specifications](#)

[Safety and Approvals Specifications](#)

## Windows System Requirements

Make sure your system meets these requirements before using it with your scanner.

- Windows 10
- Windows 8.x
- Windows 7
- Windows Vista\*
- Windows Server 2019\*
- Windows Server 2016\*
- Windows Server 2012 R2\*
- Windows Server 2012\*
- Windows Server 2008 R2\*
- Windows Server 2008\*
- Windows Server 2003 R2\*
- Windows Server 2003 Service Pack 2\*

\* Document Capture Pro does not support these Windows versions.



**Note:** For the latest product software available for your operating system, visit the Epson support site at [epson.com/support](http://epson.com/support) (U.S.), [epson.ca/support](http://epson.ca/support) (Canada), or [epson.com.jm/support](http://epson.com.jm/support) (Caribbean), select your product, and select **Downloads**.

**Parent topic:** [Technical Specifications](#)

## Mac System Requirements

Make sure your system meets these requirements before using it with your scanner.

- macOS 10.14
- macOS 10.13
- macOS 10.12
- OS X 10.11.x
- OS X 10.10.x
- OS X 10.9.x
- OS X 10.8.x
- OS X 10.7.x
- OS X 10.6.8

**Note:** The UNIX File System (UFS) and Fast User Switching are not supported for Mac.

**Note:** For the latest product software available for your operating system, visit the Epson support site at [epson.com/support](http://epson.com/support) (U.S.), [epson.ca/support](http://epson.ca/support) (Canada), or [epson.com.jm/support](http://epson.com.jm/support) (Caribbean), select your product, and select **Downloads**.

**Parent topic:** [Technical Specifications](#)

## General Specifications

<b>Scanner type</b>	Flatbed, color
<b>Photoelectric device</b>	Color CCD line sensor
<b>Effective pixels</b>	Scanner glass: 10200 × 14040 pixels at 1200 dpi ADF: 5100 × 8400 pixels at 600 dpi

<b>Document size</b>	Scanner glass: 8.5 × 11.7 inches (216 × 297 mm) ADF: 8.5 × 40 inches (216 × 1016 mm)
<b>ADF paper input</b>	Faceup loading
<b>ADF paper output</b>	Facedown ejection
<b>ADF paper capacity</b>	100 sheets of paper at approximately 20 lb (80 g/m <sup>2</sup> ) weight
<b>Scanning resolution</b>	Scanner glass: 1200 dpi main scan 1200 dpi sub scan ADF: 600 dpi main scan 600 dpi sub scan
<b>Output resolution</b>	50 to 9600 dpi (in 1 dpi increments)  Optional optical resolution is the maximum scan resolution of the CCD elements, using the definition of ISO 14473. ISO 14473 defines optical resolution as the fundamental sampling rate of the scan sensor.
<b>Image data</b>	16 bits per pixel per color internal 1 to 8 bits per pixel per color external
<b>Interface</b>	One Hi-Speed USB port
<b>Light source</b>	White LED

Parent topic: [Technical Specifications](#)

## Dimension Specifications

<b>Height</b>	8.6 inches (217 mm)
<b>Width</b>	19.5 inches (495 mm)
<b>Depth</b>	14.2 inches (360 mm)
<b>Weight</b> (without ADF input tray)	Approximately 21.6 lb (9.8 kg)

**Note:** Dimensions do not include open or extended parts.

Parent topic: [Technical Specifications](#)

## Electrical Specifications

### Scanner

<b>Rated input voltage</b>	DC 24 V
<b>Rated input current</b>	2.0 A
<b>Power consumption</b>	Operating: Approximately 44.5 W Ready mode: Approximately 12.0 W Sleep mode: Approximately 1.6 W Power off mode: Approximately 0.4 W

### AC adapter

<b>AC adapter model</b>	A471H: AC 100 to 240 V A472E: AC 220 to 240 V
<b>Rated input current</b>	1.2 A
<b>Rated frequency range</b>	50 to 60 Hz
<b>Rated output power supply voltage</b>	DC 24 V
<b>Rated output current</b>	2.0 A

Parent topic: [Technical Specifications](#)

## Environmental Specifications

<b>Temperature</b>	Operating: 41 to 95 °F (5 to 35 °C) Storage: -13 to 140 °F (-25 to 60 °C)
<b>Humidity</b> (non-condensing)	Operating: 10 to 80% RH Storage: 10 to 85% RH

**Operating conditions**

Ordinary office or home conditions

**Note:** Avoid operating the scanner in direct sunlight, near a strong light source, or in extremely dusty conditions.

Parent topic: [Technical Specifications](#)

## **Safety and Approvals Specifications**

**United States**

EMC: FCC part 15 Subpart B class B

**Canada**

EMC: CAN/CSA-CEI/IEC CISPR 22 Class B

Parent topic: [Technical Specifications](#)

---

## Notices

Check these sections for important notices about your scanner.

**Note:** Epson offers a recycling program for end of life Epson products. Please go to [this site](#) (U.S) or [this site](#) (Canada) for information on how to return your Epson products for proper disposal.

[Important Safety Instructions](#)

[Restrictions on Copying](#)

[Default Delay Times for Power Management for Epson Products](#)

[Binding Arbitration and Class Waiver](#)

[Trademarks](#)

[A Note Concerning Responsible Use of Copyrighted Materials](#)

[Copyright Notice](#)

## Important Safety Instructions

Follow these safety instructions when setting up and using the scanner:

- Read all these instructions, and follow all warnings and instructions marked on the scanner.
- Place the scanner close enough to the computer for the interface cable to reach it easily.
- Do not use with wet hands.
- When connecting this product to a computer or other device with a cable, ensure the correct orientation of the connectors. Each connector has only one correct orientation. Inserting a connector in the wrong orientation may damage both devices connected by the cable.
- Do not insert objects into any opening as they may touch dangerous voltage points or short out parts. Beware of electrical shock hazards.
- After replacing consumable parts, dispose of them correctly following the rules of your local authority. Do not disassemble them.
- Do not place heavy objects on the scanner glass and do not press down on the glass with too much force.
- Do not place or store the scanner outdoors, in a car, near excessive dirt or dust, water, heat sources, or in locations subject to shocks, vibrations, condensation, high temperature or humidity, direct sunlight, strong light sources, or rapid changes in temperature or humidity.

- Never disassemble, modify, or attempt to repair the scanner or a scanner option by yourself except as specifically explained in this guide.

### **AC Adapter**

- Do not place or store the AC adapter outdoors, in a car, near excessive dirt or dust, water, heat sources, or in locations subject to shocks, vibrations, condensation, high temperature or humidity, direct sunlight, strong light sources, or rapid changes in temperature or humidity.
- Place the scanner and the AC adapter near an electrical outlet where the adapter can be easily unplugged.
- The AC power cord should be placed to avoid abrasions, cuts, fraying, crimping, and kinking.
- Do not place objects on top of the AC power cord and do not allow the AC adapter or the power cord to be stepped on or run over. Be particularly careful to keep the AC power cord straight at the end and the point where it enters the AC adapter.
- Use only the AC adapter that comes with your scanner. Using any other adapter could cause fire, electrical shock, or injury.
- The AC adapter is designed for use with the scanner with which it was included. Do not attempt to use it with other electronic devices unless specified.
- Use only the type of power source indicated on the AC adapter's label, and always supply power directly from a standard domestic electrical outlet with the AC adapter that meets the relevant local safety standards.
- Avoid using outlets on the same circuit as photocopiers or air control systems that regularly switch on and off.
- If you use an extension cord with the scanner, make sure the total ampere rating of the devices plugged into the extension cord does not exceed the cord's ampere rating. Also, make sure the total ampere rating of all devices plugged into the wall outlet does not exceed the wall outlet's ampere rating.
- Never disassemble, modify, or attempt to repair the AC adapter by yourself except as specifically explained in the scanner's guides.
- If damage occurs to the plug, replace the cord set or consult a qualified electrician. If there are fuses in the plug, make sure you replace them with fuses of the correct size and rating.
- Unplug the scanner and the AC adapter, and refer servicing to qualified service personnel under the following conditions: The AC adapter or plug is damaged; liquid has entered the scanner or the AC adapter; the scanner or the AC adapter has been dropped or the case has been damaged; the scanner or the AC adapter does not operate normally or exhibits a distinct change in performance. (Do not adjust controls that are not covered by the operating instructions.)

- Unplug the scanner and the AC adapter before cleaning. Clean with a damp cloth only. Do not use liquid or aerosol cleaners.
- If you are not going to use the scanner for a long period, be sure to unplug the AC adapter from the electrical outlet.

**Parent topic:** [Notices](#)

## Restrictions on Copying

Observe the following restrictions to ensure responsible and legal use of your scanner.

Copying of the following items is prohibited by law:

- Bank bills, coins, government-issued marketable securities, government bond securities, and municipal securities
- Unused postage stamps, pre-stamped postcards, and other official postal items bearing valid postage
- Government-issued revenue stamps, and securities issued according to legal procedure

Exercise caution when copying the following items:

- Private marketable securities (stock certificates, negotiable notes, checks, etc.), monthly passes, concession tickets, etc.
- Passports, driver's licenses, warrants of fitness, road passes, food stamps, tickets, etc.

**Note:** Copying these items may also be prohibited by law.

### Restriction on disassembling and decompiling

You may not disassemble, decompile, or otherwise attempt to derive the source code of any software included with this product.

**Parent topic:** [Notices](#)

## Default Delay Times for Power Management for Epson Products

This product will enter sleep mode after a period of nonuse. This is to ensure that the product meets Energy Star standards of energy efficiency. More energy savings can be achieved by setting the time to sleep to a shorter interval.

**Parent topic:** [Notices](#)

# Binding Arbitration and Class Waiver

## 1. DISPUTES, BINDING INDIVIDUAL ARBITRATION, AND WAIVER OF CLASS ACTIONS AND CLASS ARBITRATIONS

1.1 **Disputes.** The terms of this Section 1 shall apply to all Disputes between you and Epson. The term "Dispute" is meant to have the broadest meaning permissible under law and includes any dispute, claim, controversy or action between you and Epson arising out of or relating to this Agreement, Epson branded products (hardware and including any related software), or other transaction involving you and Epson, whether in contract, warranty, misrepresentation, fraud, tort, intentional tort, statute, regulation, ordinance, or any other legal or equitable basis. "DISPUTE" DOES NOT INCLUDE IP CLAIMS, or more specifically, a claim or cause of action for (a) trademark infringement or dilution, (b) patent infringement, (c) copyright infringement or misuse, or (d) trade secret misappropriation (an "IP Claim"). You and Epson also agree, notwithstanding Section 1.6, that a court, not an arbitrator, may decide if a claim or cause of action is for an IP Claim.

1.2 **Binding Arbitration.** You and Epson agree that all Disputes shall be resolved by binding arbitration according to this Agreement. **ARBITRATION MEANS THAT YOU WAIVE YOUR RIGHT TO A JUDGE OR JURY IN A COURT PROCEEDING AND YOUR GROUNDS FOR APPEAL ARE LIMITED.**

Pursuant to this Agreement, binding arbitration shall be administered by JAMS, a nationally recognized arbitration authority, pursuant to its code of procedures then in effect for consumer related disputes, but excluding any rules that permit joinder or class actions in arbitration (for more detail on procedure, see Section 1.6 below). You and Epson understand and agree that (a) the Federal Arbitration Act (9 U.S.C. §1, et seq.) governs the interpretation and enforcement of this Section 1, (b) this Agreement memorializes a transaction in interstate commerce, and (c) this Section 1 shall survive termination of this Agreement.

1.3 **Pre-Arbitration Steps and Notice.** Before submitting a claim for arbitration, you and Epson agree to try, for sixty (60) days, to resolve any Dispute informally. If Epson and you do not reach an agreement to resolve the Dispute within the sixty (60) days, you or Epson may commence an arbitration. Notice to Epson must be addressed to: Epson America, Inc., ATTN: Legal Department, 3840 Kilroy Airport Way, Long Beach, CA 90806 (the "Epson Address"). The Dispute Notice to you will be sent to the most recent address Epson has in its records for you. For this reason, it is important to notify us if your address changes by emailing us at [EAILEgal@ea.epson.com](mailto:EAILEgal@ea.epson.com) or writing us at the Epson Address above. Notice of the Dispute shall include the sender's name, address and contact information, the facts giving rise to the Dispute, and the relief requested (the "Dispute Notice"). Following receipt of the Dispute Notice, Epson and you agree to act in good faith to resolve the Dispute before commencing arbitration.

1.4 **Small Claims Court.** Notwithstanding the foregoing, you may bring an individual action in the small claims court of your state or municipality if the action is within that court's jurisdiction and is pending only in that court.



**1.5 WAIVER OF CLASS ACTIONS AND CLASS ARBITRATIONS. YOU AND EPSON AGREE THAT EACH PARTY MAY BRING DISPUTES AGAINST THE OTHER PARTY ONLY IN AN INDIVIDUAL CAPACITY, AND NOT AS A PLAINTIFF OR CLASS MEMBER IN ANY CLASS OR REPRESENTATIVE PROCEEDING, INCLUDING WITHOUT LIMITATION FEDERAL OR STATE CLASS ACTIONS, OR CLASS ARBITRATIONS. CLASS ACTION LAWSUITS, CLASS-WIDE ARBITRATIONS, PRIVATE ATTORNEY-GENERAL ACTIONS, AND ANY OTHER PROCEEDING WHERE SOMEONE ACTS IN A REPRESENTATIVE CAPACITY ARE NOT ALLOWED. ACCORDINGLY, UNDER THE ARBITRATION PROCEDURES OUTLINED IN THIS SECTION, AN ARBITRATOR SHALL NOT COMBINE OR CONSOLIDATE MORE THAN ONE PARTY'S CLAIMS WITHOUT THE WRITTEN CONSENT OF ALL AFFECTED PARTIES TO AN ARBITRATION PROCEEDING.**

**1.6 Arbitration Procedure.** If you or Epson commences arbitration, the arbitration shall be governed by the rules of JAMS that are in effect when the arbitration is filed, excluding any rules that permit arbitration on a class or representative basis (the "JAMS Rules"), available at <http://www.jamsadr.com> or by calling 1-800-352-5267, and under the rules set forth in this Agreement. All Disputes shall be resolved by a single neutral arbitrator, and both parties shall have a reasonable opportunity to participate in the selection of the arbitrator. The arbitrator is bound by the terms of this Agreement. The arbitrator, and not any federal, state or local court or agency, shall have exclusive authority to resolve all disputes arising out of or relating to the interpretation, applicability, enforceability or formation of this Agreement, including any claim that all or any part of this Agreement is void or voidable. Notwithstanding this broad delegation of authority to the arbitrator, a court may determine the limited question of whether a claim or cause of action is for an IP Claim, which is excluded from the definition of "Disputes" in Section 1.1 above. The arbitrator shall be empowered to grant whatever relief would be available in a court under law or in equity. The arbitrator may award you the same damages as a court could, and may award declaratory or injunctive relief only in favor of the individual party seeking relief and only to the extent necessary to provide relief warranted by that party's individual claim. In some instances, the costs of arbitration can exceed the costs of litigation and the right to discovery may be more limited in arbitration than in court. The arbitrator's award is binding and may be entered as a judgment in any court of competent jurisdiction.

You may choose to engage in arbitration hearings by telephone. Arbitration hearings not conducted by telephone shall take place in a location reasonably accessible from your primary residence, or in Orange County, California, at your option.

a) Initiation of Arbitration Proceeding. If either you or Epson decides to arbitrate a Dispute, both parties agree to the following procedure:

(i) Write a Demand for Arbitration. The demand must include a description of the Dispute and the amount of damages sought to be recovered. You can find a copy of a Demand for Arbitration at <http://www.jamsadr.com> ("Demand for Arbitration").

(ii) Send three copies of the Demand for Arbitration, plus the appropriate filing fee, to: JAMS, 500 North State College Blvd., Suite 600 Orange, CA 92868, U.S.A.

(iii) Send one copy of the Demand for Arbitration to the other party (same address as the Dispute Notice), or as otherwise agreed by the parties.

b) Hearing Format. During the arbitration, the amount of any settlement offer made shall not be disclosed to the arbitrator until after the arbitrator determines the amount, if any, to which you or Epson is entitled. The discovery or exchange of non-privileged information relevant to the Dispute may be allowed during the arbitration.

c) Arbitration Fees. Epson shall pay, or (if applicable) reimburse you for, all JAMS filings and arbitrator fees for any arbitration commenced (by you or Epson) pursuant to provisions of this Agreement.

d) Award in Your Favor. For Disputes in which you or Epson seeks \$75,000 or less in damages exclusive of attorney's fees and costs, if the arbitrator's decision results in an award to you in an amount greater than Epson's last written offer, if any, to settle the Dispute, Epson will: (i) pay you \$1,000 or the amount of the award, whichever is greater; (ii) pay you twice the amount of your reasonable attorney's fees, if any; and (iii) reimburse you for any expenses (including expert witness fees and costs) that your attorney reasonably accrues for investigating, preparing, and pursuing the Dispute in arbitration. Except as agreed upon by you and Epson in writing, the arbitrator shall determine the amount of fees, costs, and expenses to be paid by Epson pursuant to this Section 1.6d).

e) Attorney's Fees. Epson will not seek its attorney's fees and expenses for any arbitration commenced involving a Dispute under this Agreement. Your right to attorney's fees and expenses under Section 1.6d) above does not limit your rights to attorney's fees and expenses under applicable law; notwithstanding the foregoing, the arbitrator may not award duplicative awards of attorney's fees and expenses.

**1.7 Opt-out. You may elect to opt-out (exclude yourself) from the final, binding, individual arbitration procedure and waiver of class and representative proceedings specified in this Agreement by sending a written letter to the Epson Address within thirty (30) days of your assent to this Agreement (including without limitation the purchase, download, installation of the Software or other applicable use of Epson Hardware, products and services) that specifies (i) your name, (ii) your mailing address, and (iii) your request to be excluded from the final, binding individual arbitration procedure and waiver of class and representative proceedings specified in this Section 1. In the event that you opt-out consistent with the procedure set forth above, all other terms shall continue to apply, including the requirement to provide notice prior to litigation.**

**1.8 Amendments to Section 1.** Notwithstanding any provision in this Agreement to the contrary, you and Epson agree that if Epson makes any future amendments to the dispute resolution procedure and class action waiver provisions (other than a change to Epson's address) in this Agreement, Epson will obtain your affirmative assent to the applicable amendment. If you do not affirmatively assent to the applicable amendment, you are agreeing that you will arbitrate any Dispute between the parties in accordance with the language of this Section 1 (or resolve disputes as provided for in Section 1.7, if you timely elected to opt-out when you first assented to this Agreement).

**1.9 Severability.** If any provision in this Section 1 is found to be unenforceable, that provision shall be severed with the remainder of this Agreement remaining in full force and effect. **The foregoing shall not apply to the prohibition against class or representative actions as provided in Section 1.5. This means that if Section 1.5 is found to be unenforceable, the entire Section 1 (but only Section 1) shall be null and void.**

Parent topic: [Notices](#)

## Trademarks

EPSON® is a registered trademark and EPSON Exceed Your Vision is a registered logomark of Seiko Epson Corporation.

Windows is a registered trademark of Microsoft Corporation in the United States and/or other countries.

Apple, macOS, and OS X are trademarks of Apple Inc., registered in the U.S. and other countries.

General Notice: Other product names used herein are for identification purposes only and may be trademarks of their respective owners. Epson disclaims any and all rights in those marks.



Parent topic: [Notices](#)

## A Note Concerning Responsible Use of Copyrighted Materials

Epson encourages each user to be responsible and respectful of the copyright laws when using any Epson product. While some countries' laws permit limited copying or reuse of copyrighted material in certain circumstances, those circumstances may not be as broad as some people assume. Contact your legal advisor for any questions regarding copyright law.

Parent topic: [Notices](#)

## Copyright Notice

All rights reserved. No part of this publication may be reproduced, stored in a retrieval system, or transmitted in any form or by any means, electronic, mechanical, photocopying, recording, or otherwise, without the prior written permission of Seiko Epson Corporation. The information contained herein is designed only for use with this Epson product. Epson is not responsible for any use of this information as applied to other products.

Neither Seiko Epson Corporation nor its affiliates shall be liable to the purchaser of this product or third parties for damages, losses, costs, or expenses incurred by purchaser or third parties as a result of: accident, misuse, or abuse of this product or unauthorized modifications, repairs, or alterations to this product, or (excluding the U.S.) failure to strictly comply with Seiko Epson Corporation's operating and maintenance instructions.

Seiko Epson Corporation shall not be liable for any damages or problems arising from the use of any options or any consumable products other than those designated as Original Epson Products or Epson Approved Products by Seiko Epson Corporation.

Seiko Epson Corporation shall not be held liable for any damage resulting from electromagnetic interference that occurs from the use of any interface cables other than those designated as Epson approved Products by Seiko Epson Corporation.

This information is subject to change without notice.

[Copyright Attribution](#)

**Parent topic:** [Notices](#)

## **Copyright Attribution**

© 2019 Epson America, Inc.

12/19

CPD-35544R4

**Parent topic:** [Copyright Notice](#)