

DS-730N User's Guide

Contents

DS-730N User's Guide	7
Scanner Basics	8
Using the Control Panel	8
Control Panel Buttons and Lights	9
The LCD Screen	10
Viewing Animations.....	10
Status Icon Information	12
Adjusting the Screen Brightness.....	12
Changing LCD Screen Language.....	13
Selecting the Date and Time	14
Changing the Keyboard Layout	16
Selecting the Start-up Screen.....	16
Turning Off the Operation Time Out Setting	17
Preventing PC Connection via USB	18
Setting Direct Power On	19
Changing Regular Cleaning Alert Settings	20
Changing Roller Replacement Alert Settings	21
Setting a Password and Locking the Control Panel	22
Scanner Parts Locations	24
Scanner Parts.....	24
User Replaceable Epson Scanner Parts	26
Using Power Saving Settings	27
Changing the Sleep Timer Settings.....	27
Changing the Power Off Timer Settings	28
Loading Originals	30
Loading Originals in the Input Tray.....	30
Loading Multiple Sizes of Originals in the Input Tray	37
Original Document Specifications.....	40
Loading Plastic and Laminated Cards in the Input Tray	42
Plastic and Laminated Card Specifications	46

Loading Special Originals.....	46
Special Original Specifications	54
Wired Networking	56
Network Security Recommendations	56
Wired Network Setup	56
Connecting the Product to the Network.....	57
Determining the Scanner's IP Address	58
Accessing the Web Config Utility.....	58
Registering Presets or Quick Send Buttons.....	59
Scanning	60
Starting a Scan.....	60
Scanning Using the Product Control Panel	60
Setting the Operation Mode on the Product Control Panel.....	61
Scanning Using the Quick Send Buttons	61
Scanning Using Presets.....	62
Scanning Originals to the Computer	62
Scanning Using Web Services for Devices (WSD) - Windows.....	63
Adding and Assigning Scan Jobs with Document Capture Pro - Windows	64
Adding and Assigning Scan Jobs with Document Capture - Mac.....	67
Starting a Scan Using the Epson Scan 2 Icon	68
Starting a Scan from a Scanning Program.....	70
Scanning with Simple Scan in Document Capture Pro - Windows	72
Scanning with Job Scan in Document Capture Pro - Windows	73
Scanning with Document Capture - Mac	74
Scanning in Epson Scan 2	78
Additional Scanning Settings - Main Settings Tab	82
Additional Scanning Settings - Advanced Settings Tab	83
Scanning Settings for Special Documents.....	84
Image Format Options	85
Scan Resolution Guidelines	86
Scanning Special Projects.....	86
Scanning Two Originals onto One Sheet (Stitching Images) - Windows	87
Scanning Multi-Page Originals as Separate Files - Windows	90

Saving Scanned Documents as a Searchable PDF Using Epson Scan 2	92
Saving a Scan as an Office Format File - Windows	94
Scanning to a SharePoint Server or Cloud Service - Windows.....	95
Scanning to a SharePoint Server or Cloud Service - Mac	97
Cleaning and Transporting Your Scanner.....	99
Cleaning Your Scanner	99
Cleaning Inside Your Scanner.....	99
Checking the Scanner Roller Counter	110
Replacing the Scanner Rollers.....	111
Resetting the Scanner Roller Counter	116
Transporting Your Scanner	117
Solving Problems	119
Product Status Messages	119
Solving Scanning Problems	120
Scanner Does Not Turn On or Turns Off Unexpectedly.....	120
Scanner Button Does Not Work as Expected	121
Scanning Software Does Not Operate Correctly	121
Cannot Start Epson Scan 2	122
Original Feeds Incorrectly in Scanner.....	123
Original Jams in Scanner.....	124
Scanning is Slow	126
Cannot Scan Over a Network	126
Solving Scanned Image Quality Problems	127
Back of Original Image Appears in Scanned Image	128
Scanned Characters are Blurry	128
Characters are not Recognized During Conversion to Editable Text (OCR)	129
Ripple Patterns Appear in an Image	129
Spots or Lines Appear in All Scanned Images.....	130
Scanned Image is Cropped	130
Resetting the Epson Scan 2 Settings	131
Uninstall Your Scanner Software.....	131
Uninstalling Scanner Software - Windows.....	131
Uninstalling Scanner Software - Mac.....	132

Where to Get Help (U.S. and Canada)	133
Where to Get Help (Latin America).....	134
Technical Specifications	136
Windows System Requirements	136
Mac System Requirements	137
General Specifications	137
Dimension Specifications	139
Electrical Specifications	139
Environmental Specifications	140
Network Interface Specifications	140
Safety and Approvals Specifications	141
Notices	142
Important Safety Instructions.....	142
Restrictions on Copying	144
Default Delay Times for Power Management for Epson Products.....	145
Binding Arbitration and Class Waiver	145
Trademarks	148
Copyright Notice.....	149
libTIFF Software Acknowledgment.....	149
A Note Concerning Responsible Use of Copyrighted Materials.....	150
Copyright Attribution	150

DS-730N User's Guide

Welcome to the DS-730N *User's Guide*.

For a printable PDF copy of this guide, [click here](#).

Scanner Basics

See these sections to learn about the basic features of your scanner.

[Using the Control Panel](#)

[Scanner Parts Locations](#)

[User Replaceable Epson Scanner Parts](#)

[Using Power Saving Settings](#)

Using the Control Panel

See these sections to learn about the control panel and select control panel settings.

[Control Panel Buttons and Lights](#)

[Adjusting the Screen Brightness](#)

[Changing LCD Screen Language](#)

[Selecting the Date and Time](#)

[Changing the Keyboard Layout](#)

[Selecting the Start-up Screen](#)

[Turning Off the Operation Time Out Setting](#)

[Preventing PC Connection via USB](#)

[Setting Direct Power On](#)

[Changing Regular Cleaning Alert Settings](#)

[Changing Roller Replacement Alert Settings](#)

[Setting a Password and Locking the Control Panel](#)

Parent topic: [Scanner Basics](#)

Control Panel Buttons and Lights

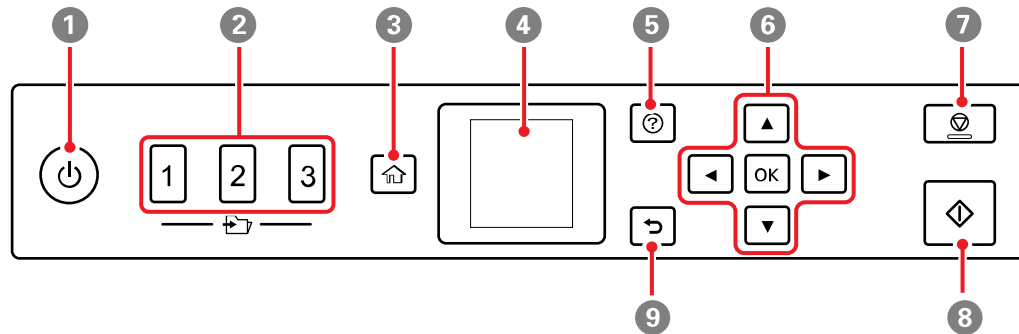

- 1 ⏻ power button and the ⏻ power light
- 2 📁 Quick Send buttons
- 3 🏠 home button
- 4 LCD screen
- 5 ❓ help button
- 6 Navigation arrows and the **OK** button
- 7 🛑 stop button
- 8 ⬠ start button
- 9 ↶ back button

[The LCD Screen](#)

[Viewing Animations](#)

[Status Icon Information](#)

Parent topic: [Using the Control Panel](#)

The LCD Screen

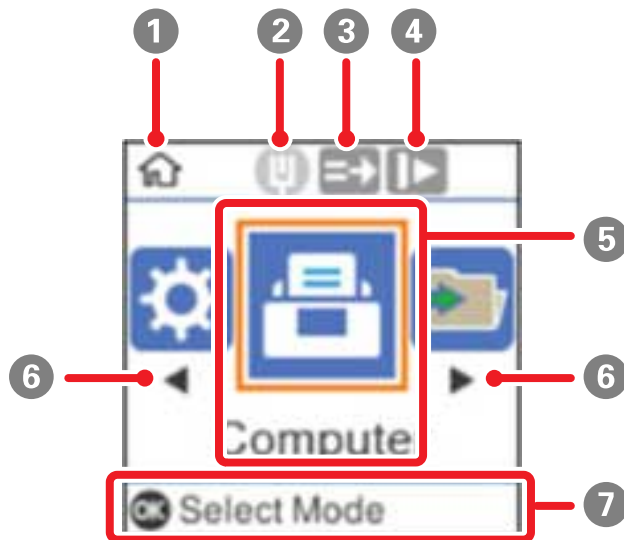

- 1 Home screen indicator
- 2 Displays the network connection status
- 3 Double Feed Detection Skip (DFDS) is enabled (blue) or disabled. Select the **DFDS Function** option in the Scanner Settings menu to change the setting.
- 4 Slow mode is enabled (blue) or disabled. Select the **Slow** option in the Scanner Settings menu to change the setting.
- 5 Displays available menus
- 6 Press the arrow button to scroll through available menus
- 7 Displays available button actions

Parent topic: [Control Panel Buttons and Lights](#)

Viewing Animations

You can view animations on the LCD screen to help guide you with a procedure or to troubleshoot a problem.

1. Press the ⓘ help button to display the Help screen.

You see a screen like this:

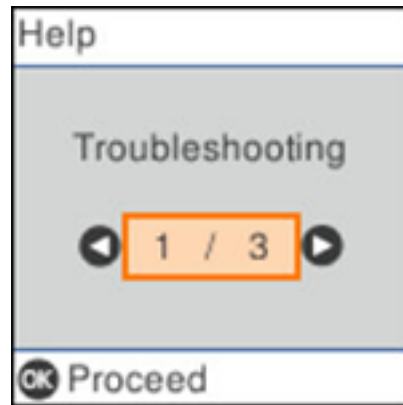

2. Select **Troubleshooting** if you are experiencing a problem or **How To** to view instructions on common procedures.
3. Select a topic from the list of available topics and follow the on-screen instructions.

While viewing the topics, you may see screens like this:

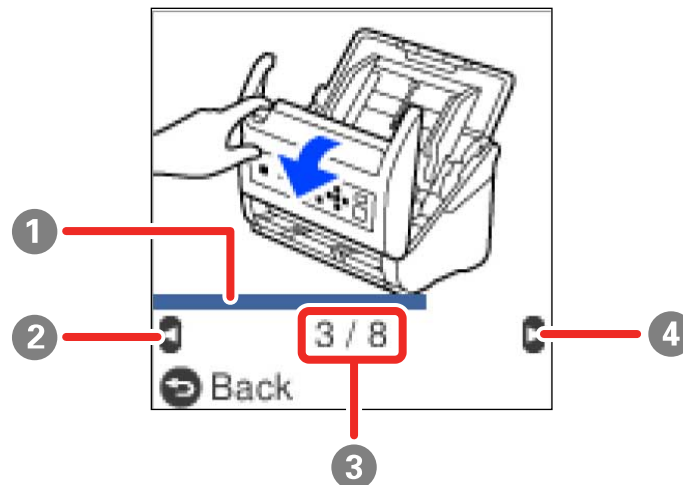









- 1 Indicates your overall progress through the animation
- 2 Press the left arrow button to view the previous step
- 3 Displays the current step number and the total number of steps
- 4 Press the right arrow button to view the next step

Parent topic: [Control Panel Buttons and Lights](#)

Status Icon Information

Your product displays status icons on the LCD screen for certain product status conditions.

Icons	Description
	Indicates that you are on the home screen.
	Slow mode is enabled. Paper feeding speed is reduced during scanning.
	Slow mode is disabled.
	Double Feed Detection Skip (DFDS) is enabled. Double feed detection is skipped once during scanning. (Enable DFDS to scan originals, such as plastic cards or envelopes, that are detected as double feeds.)
	Double Feed Detection Skip (DFDS) is disabled.
	Network connection enabled.
	Network connection disabled.
	There is a problem with the indicated setting. See the Device Information menu to resolve the problem.

Parent topic: [Control Panel Buttons and Lights](#)

Adjusting the Screen Brightness

You can adjust the brightness of the LCD screen.

1. Press the  home button, if necessary.
2. Use the arrow buttons to select **Settings** and press the **OK** button.

You see a screen like this:



3. Press the **OK** button.
4. Use the arrow buttons to select **LCD Brightness** and press the **OK** button.
5. Use the arrow buttons to decrease or increase the brightness.
6. Press the **OK** button to exit.

Parent topic: [Using the Control Panel](#)

Changing LCD Screen Language

You can change the language used on the LCD screen.

Note: This setting can be locked by an administrator. If you cannot access or change this setting, contact your administrator for assistance.

1. Press the  home button, if necessary.
2. Use the arrow buttons to select **Settings** and press the **OK** button.

You see a screen like this:

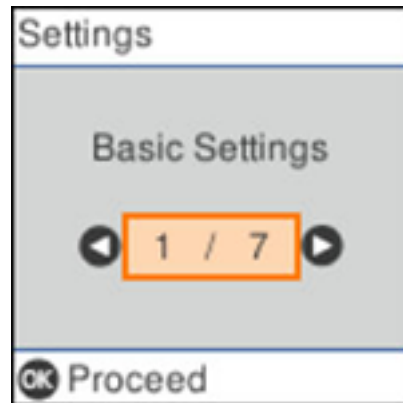

3. Press the **OK** button.
4. Use the arrow buttons to select **Language** and press the **OK** button.
5. Select a language and press the **OK** button to exit.

Parent topic: [Using the Control Panel](#)

Selecting the Date and Time

Before using your product, select the current date, time, and daylight saving phase in your area, and choose your preferred date and time format.

Note: This setting can be locked by an administrator. If you cannot access or change this setting, contact your administrator for assistance.

1. Press the  home button, if necessary.
2. Use the arrow buttons to select **Settings** and press the **OK** button.

You see a screen like this:



3. Press the **OK** button.
 4. Use the arrow buttons to select **Date/Time Settings** and press **OK**.
 5. Press the **OK** button to select **Date/Time**.
 6. Use the arrow buttons to select the date format you want to use.
 7. Use the arrow buttons to enter the current date and press **OK**.
 8. Use the arrow buttons to select the time format you want to use and press **OK**.
 9. Use the arrow buttons to enter the current time and press **OK**.
 10. Use the arrow buttons to select **Daylight Saving Time** and press **OK**.
 11. Select the setting that applies to your area:
 - **Winter**: it is winter or your region does not use Daylight Saving Time (DST)
 - **Summer**: it is spring or summer and your region uses Daylight Saving Time (DST)
- Note:** If your region uses Daylight Saving Time (DST), you must change this setting to match the season. When you change from **Winter** to **Summer**, your product automatically sets its clock ahead one hour. When you change from **Summer** to **Winter**, it sets its clock back one hour.
12. Use the arrow buttons to select **Time Difference** and press **OK**.
 13. Use the arrow buttons to enter the time difference between your local time and UTC (Coordinated Universal Time) and press **OK**.

Parent topic: [Using the Control Panel](#)

Changing the Keyboard Layout

You can change the layout of the keyboard on the control panel.

1. Press the  home button, if necessary.
2. Use the arrow buttons to select **Settings** and press the **OK** button.

You see a screen like this:



3. Press the **OK** button.
4. Use the arrow buttons to select **Keyboard** and press the **OK** button.
5. Select the layout you want to use and press the **OK** button to exit.

Parent topic: [Using the Control Panel](#)

Selecting the Start-up Screen

You can choose the initial menu that displays on the LCD screen when the scanner is turned on and **Operation Time Out** is enabled.

Note: This setting can be locked by an administrator. If you cannot access or change this setting, contact your administrator for assistance.

1. Press the  home button, if necessary.

2. Use the arrow buttons to select **Settings** and press the **OK** button.

You see a screen like this:

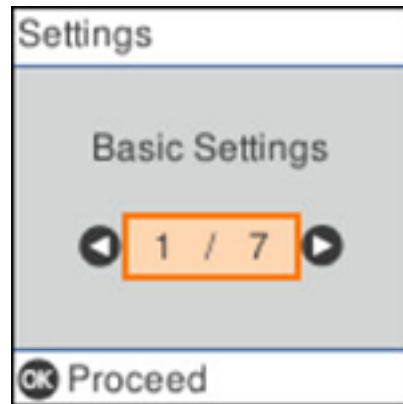

3. Press the **OK** button.
4. Use the arrow buttons to select **Start-up Screen** and press the **OK** button.
5. Use the arrow buttons to select the menu you want to see on the LCD screen (**Home**, **Quick Send**, or **Presets**) when the scanner is powered on.
6. Press the **OK** button to exit.

Parent topic: [Using the Control Panel](#)

Turning Off the Operation Time Out Setting

The Operation Time Out setting causes the LCD screen to return to the Home screen after a few minutes of inactivity. This feature is enabled by default, but you can turn it off.

Note: This setting can be locked by an administrator. If you cannot access or change this setting, contact your administrator for assistance.

1. Press the  home button, if necessary.
2. Use the arrow buttons to select **Settings** and press the **OK** button.

You see a screen like this:



3. Press the **OK** button.
4. Use the arrow buttons to select **Operation Time Out** and press the **OK** button.
5. Select **Modify** and press the **OK** button.
6. Select **Off** and press the **OK** button.

Parent topic: [Using the Control Panel](#)

Preventing PC Connection via USB

You can disable access from a USB-connected computer. This restricts non-network access to the product and protects the security of confidential scanned documents.

Note: This setting can be locked by an administrator. If you cannot access or change this setting, contact your administrator for assistance.

1. Press the  home button, if necessary.
2. Use the arrow buttons to select **Settings** and press the **OK** button.

You see a screen like this:



3. Press the **OK** button.
4. Select **PC Connection via USB**.
5. Select **Disable**.

Parent topic: [Using the Control Panel](#)

Setting Direct Power On

You can turn on the scanner directly when the scanner is connected to the power source, without pressing the power button.

Note: This setting can be locked by an administrator. If you cannot access or change this setting, contact your administrator for assistance.

1. Press the  home button, if necessary.
2. Use the arrow buttons to select **Settings** and press the **OK** button.

You see a screen like this:



3. Press the **OK** button.
4. Use the arrow buttons to select **Direct Power On** and press the **OK** button.
5. Select **On** and press the **OK** button to exit.

Parent topic: [Using the Control Panel](#)

Changing Regular Cleaning Alert Settings

You can set an alert to appear to remind you to perform regular cleaning after a certain number of scans.

Note: This setting can be locked by an administrator. If you cannot access or change this setting, contact your administrator for assistance.

1. Press the  home button, if necessary.
2. Use the arrow buttons to select **Settings** and press the **OK** button.

You see a screen like this:



3. Use the arrow buttons to select **Regular Cleaning Alert Settings** and press the **OK** button.
4. Do the following:
 - Set the **Warning Alert Setting** to **On** to receive a notification when it is time to clean inside the scanner.
 - On the **Count Alert Setting** screen, use the arrow buttons to change the number of scans before the notification appears.
5. Press the **OK** button to exit.

Parent topic: [Using the Control Panel](#)

Changing Roller Replacement Alert Settings

You can set an alert to appear to remind you to replace the roller after a certain number of scans.

Note: This setting can be locked by an administrator. If you cannot access or change this setting, contact your administrator for assistance.

1. Press the  home button, if necessary.
2. Use the arrow buttons to select **Settings** and press the **OK** button.

You see a screen like this:

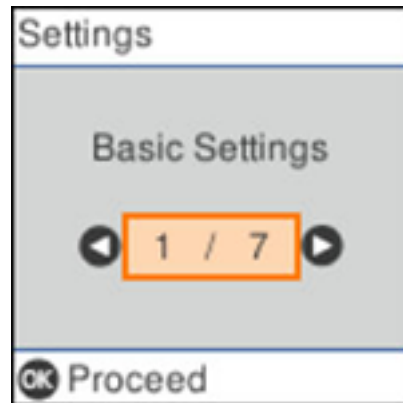

3. Use the arrow buttons to select **Roller Replacement Alert Settings** and press the **OK** button.
4. Use the arrow buttons to change the number of scans before the notification appears.
5. Press the **OK** button to exit.

Parent topic: [Using the Control Panel](#)

Setting a Password and Locking the Control Panel

You can set an administrator password to lock the following settings and prevent them from being changed:

Note: You should set an administrator password and keep it in a safe place. You must know the administrator password in order to change or delete it. If you forget the password or inadvertently set it, the product will need to be sent to Epson for service.

- Network settings
- Web Service settings
- Scanner settings
- System Administration settings
- Web Config settings
- EpsonNet Config settings

Note: For more information on administration settings, see the [Administrator's Guide](#).

1. Press the  home button, if necessary.
2. Use the arrow buttons to select **Settings** and press the **OK** button.

You see a screen like this:

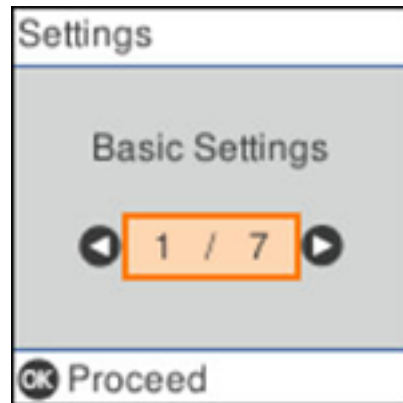

3. Press the **OK** button.
4. Use the arrow buttons to select **System Administration** and press the **OK** button.
5. Select **Admin Settings** and press the **OK** button.
6. Select **Admin Password > Register**.
7. Use the displayed keyboard to enter a password and press **OK**.
8. Enter your password again to confirm.

Note: Keep a copy of your password in a safe place.

9. Press the **OK** button to exit.

When the control panel is locked, you must enter the password to access any of the locked settings. You can change or delete the administrator password by entering the password and selecting **Change** or **Reset** on the Admin Password screen.

Parent topic: [Using the Control Panel](#)

Scanner Parts Locations

See these sections to identify the parts on your scanner.

[Scanner Parts](#)

Parent topic: [Scanner Basics](#)

Scanner Parts

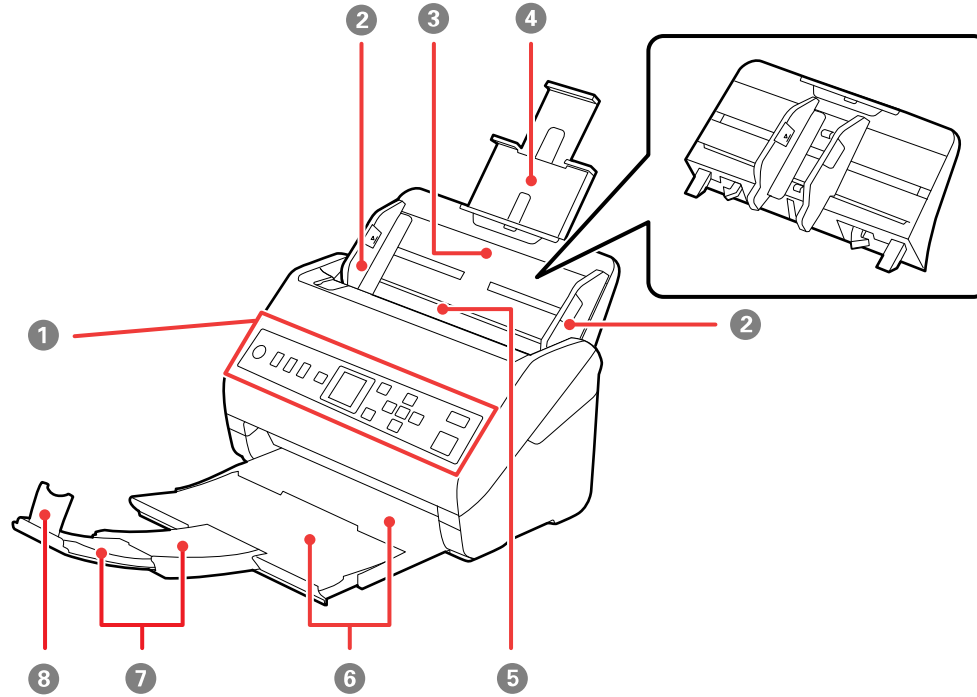

- 1 Control panel
- 2 Edge guides
- 3 Input tray
- 4 Input tray extension
- 5 ADF (Automatic Document Feeder)

- 6 Output tray
- 7 Output tray extensions
- 8 Stopper

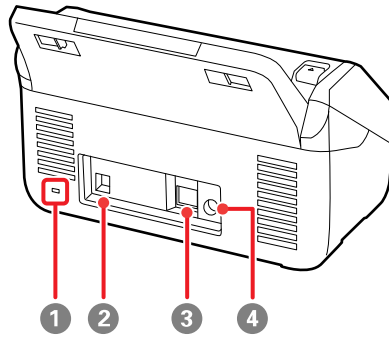

- 1 Kensington security slot
- 2 USB port
- 3 LAN port

4 Power inlet

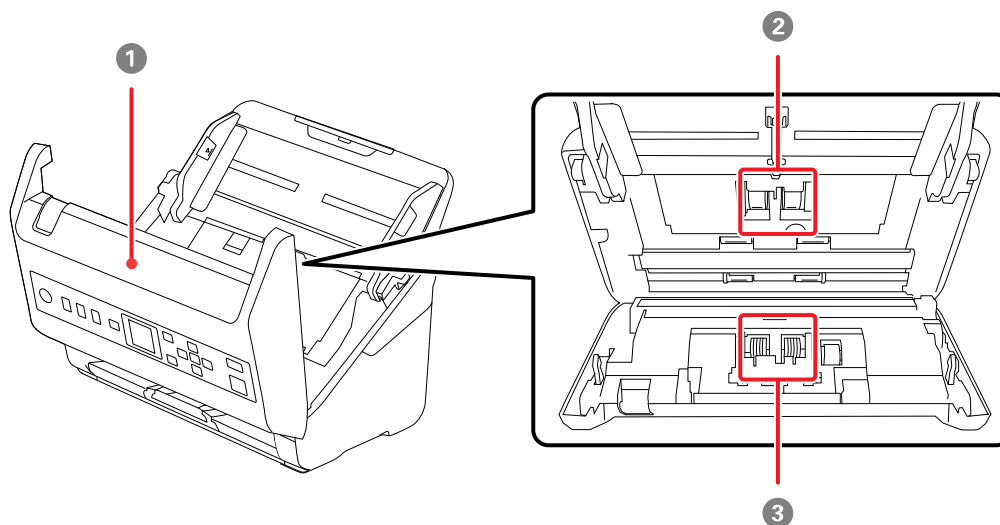

- 1 Scanner cover
- 2 Pickup roller
- 3 Separation roller

Parent topic: [Scanner Parts Locations](#)

User Replaceable Epson Scanner Parts

U.S. and Canada: You can purchase genuine Epson accessories at epson.com (U.S. sales) or epson.ca (Canadian sales). You can also purchase accessories from an Epson authorized reseller. To find the nearest one, call 800-GO-EPSON (800-463-7766) in the U.S. or 800-807-7766 in Canada.

Latin America: You can purchase optional accessories and replacement parts from an Epson authorized reseller. To find the nearest reseller, go to latin.epson.com. Or you can contact your nearest sales office as described in "Where to Get Help".

Note: Availability of accessories varies by country.

Part	Part number
Carrier sheet (5)	B12B819051
Roller assembly kit	B12B819671
Cleaning kit	B12B819291

Parent topic: [Scanner Basics](#)

Using Power Saving Settings

Your scanner enters sleep mode automatically and turns off the LCD screen if it is not used for a period of time. You can make the time period shorter to save energy and resources.

[Changing the Sleep Timer Settings](#)

[Changing the Power Off Timer Settings](#)

Parent topic: [Scanner Basics](#)

Changing the Sleep Timer Settings

You can adjust the time period before your product enters sleep mode and turns off the LCD screen.

Note: This setting can be locked by an administrator. If you cannot access or change this setting, contact your administrator for assistance.

1. Press the  home button, if necessary.
2. Use the arrow buttons to select **Settings** and press the **OK** button.

You see a screen like this:



3. Press the **OK** button.
4. Use the arrow buttons to select **Sleep Timer** and press the **OK** button.
5. Do one of the following:
 - Press the up or down arrow buttons to decrease or increase the number of minutes.
 - Press the left and right arrow buttons to move to the previous or next character.
6. Press the **OK** button to exit.

Parent topic: [Using Power Saving Settings](#)

Changing the Power Off Timer Settings

You can have the product turn off automatically if it is not used for a specified period of time.

Note: This setting can be locked by an administrator. If you cannot access or change this setting, contact your administrator for assistance.

1. Press the  home button, if necessary.
2. Use the arrow buttons to select **Settings** and press the **OK** button.

You see a screen like this:



3. Press the **OK** button.
4. Use the arrow buttons to select **Power Off Timer** and press the **OK** button.
5. Select **Off** or select a time period between **30minutes** and **12h** (12 hours).
6. Press the **OK** button to exit.

Parent topic: [Using Power Saving Settings](#)

Loading Originals

Follow the instructions here to load your originals into the scanner.

[Loading Originals in the Input Tray](#)

[Loading Plastic and Laminated Cards in the Input Tray](#)

[Loading Special Originals](#)

Loading Originals in the Input Tray

You can load originals that meet the document specifications in the input tray.

Caution: Do not load photos, or valuable original documents or artwork, directly into the input tray. This may wrinkle or damage the original. Load these originals using an optional carrier sheet.

Note: Photos scanned using a document scanner may not have the same color depth as the original. Use a flatbed photo scanner to achieve the best color reproduction of photos.

The steps below describe loading originals of the same size. To load originals of multiple sizes at once, see the link at the end of these steps.

1. Pull up the input tray extension.

2. Pull out the output tray and its extension, and open the stopper.

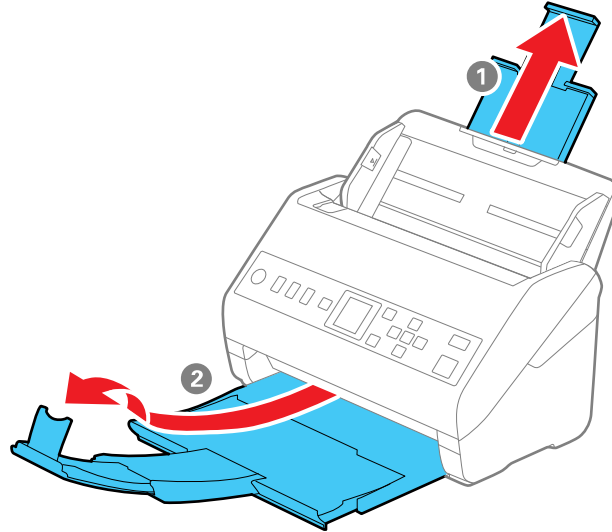

Note: If you are loading an original that is 15.5 inches (393.8 mm) or longer, do not pull out the input or output tray extensions and do not open the stopper.

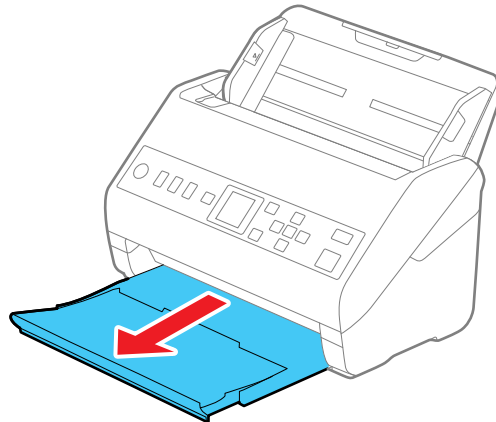

- Slide the input tray edge guides all the way out.

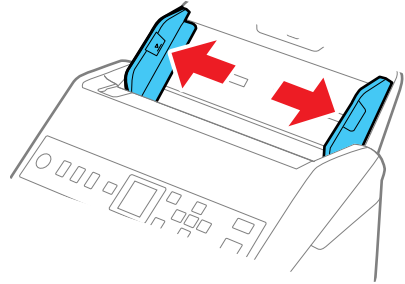

- If you are loading a multi-page original, fan your stack of originals.

Note: If you are loading an original that is 15.5 inches (393.8 mm) or longer, load only one sheet at a time.

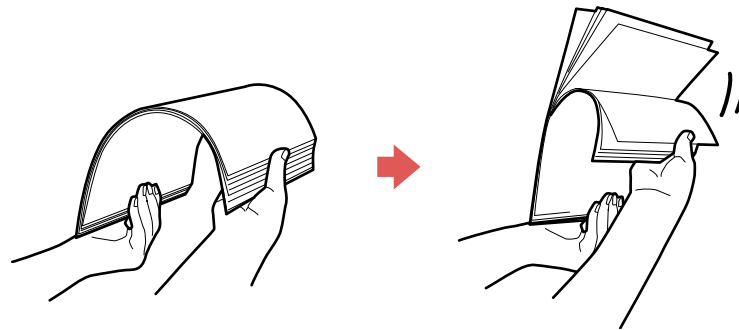

- Stack the originals with the printed side facing down and slide the stack so the leading edge is at an angle as shown.

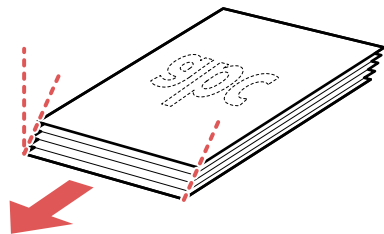

6. Load standard originals into the input tray printed side down and top edge first, and guide them in until they meet resistance.

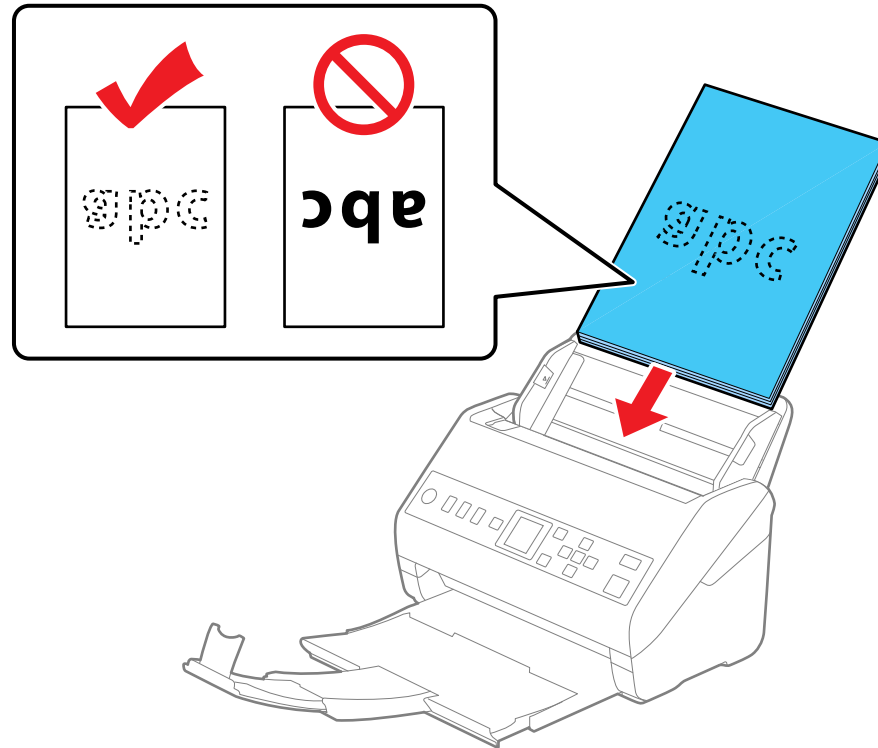

- If you are loading paper business cards, load up to 30 cards (printed side down and long edge first) into the input tray horizontally, and slide them in until they meet resistance.

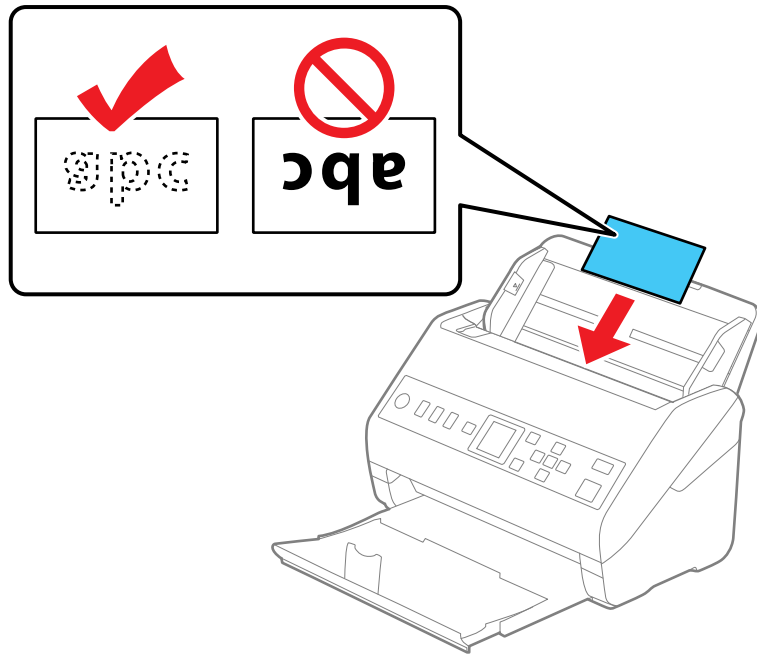

- If you are loading hole-punched originals, load them with the holes facing down or to the side as shown. The holes must be within 1.2 inches (30 mm) of the edge of the originals.

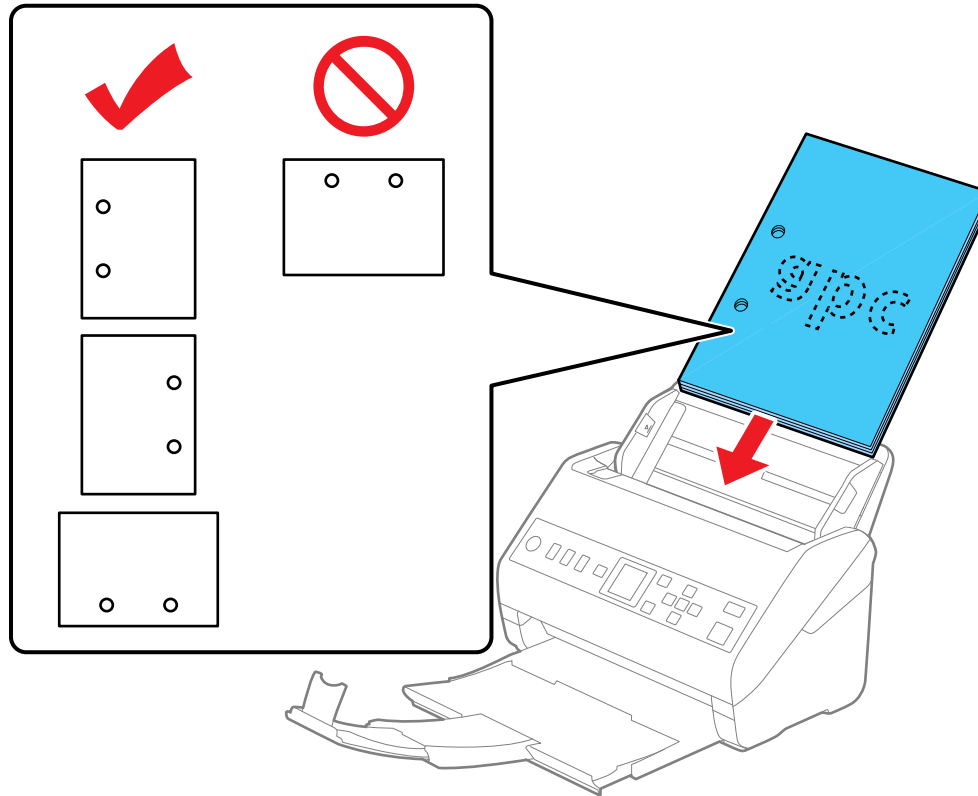

7. Slide the edge guides against the edges of the original.

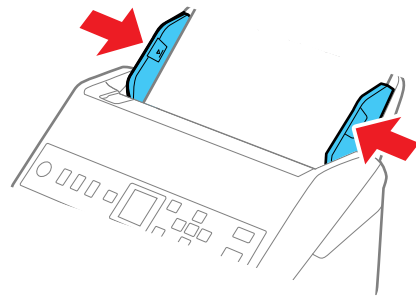

Note: If you are scanning originals that are 15.5 inches (393.8 mm) or longer, support the original as it enters into and ejects from the scanner as shown and use the following resolutions:

- 11.6 to 53 inches (393.8 to 1346.2 mm): 301 to 600 dpi
- 53 to 215 inches (1346.3 to 5461 mm): 201 to 300 dpi
- 215 to 240 inches (5461.1 to 6096 mm): 50 to 200 dpi

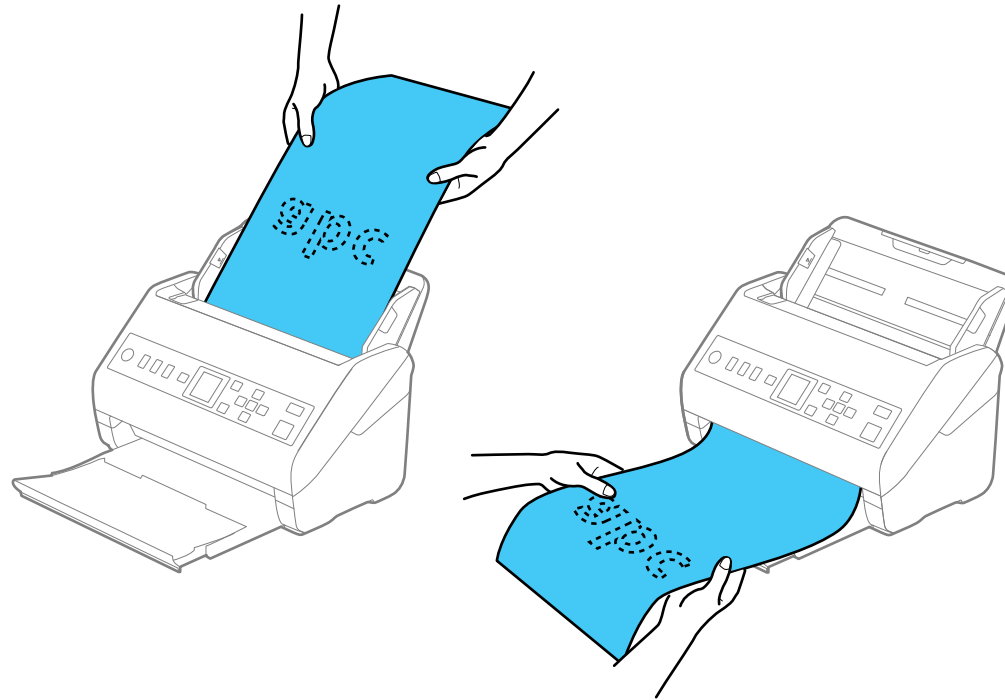

8. If necessary during scanning, adjust the position of the stopper on the output tray extension to fit the ejected originals.

Note: If thicker paper does not eject properly or falls from the output tray, push in the output tray and allow the originals to eject freely onto the surface below the scanner. If the scanned images are affected by the originals ejecting below the scanner, try placing the scanner on the edge of a table where the ejected originals can drop freely.

If scanning thin or wrinkled paper causes paper jams, slow down the feeding speed by selecting **Settings > Scanner Settings > Slow > On** on the LCD screen.

[Loading Multiple Sizes of Originals in the Input Tray](#)

[Original Document Specifications](#)

Parent topic: [Loading Originals](#)

Loading Multiple Sizes of Originals in the Input Tray

You can load originals of different sizes, paper types, and thicknesses at one time in the input tray. Just make sure they meet the original document specifications.

Caution: Do not load photos, or valuable original documents or artwork, directly into the input tray. This may wrinkle or damage the original. Load these originals using an optional carrier sheet.

1. Pull up the input tray extension.
2. Pull out the output tray and its extension, and open the stopper.

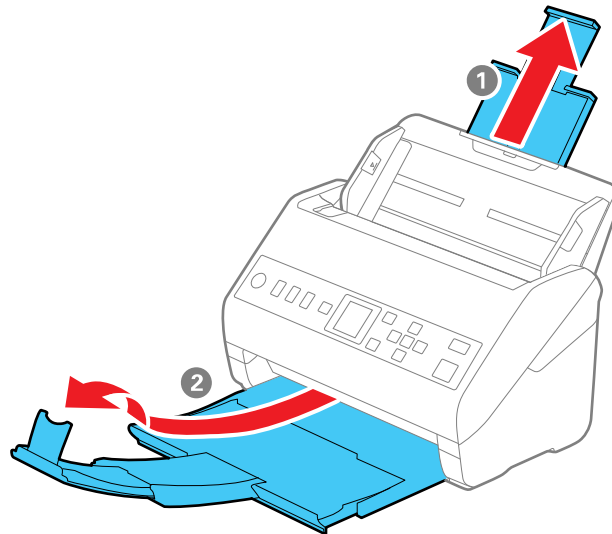

Note: If you are loading originals that are 15.5 inches (393.8 mm) or longer, do not pull out the input or output tray extensions and do not open the stopper.

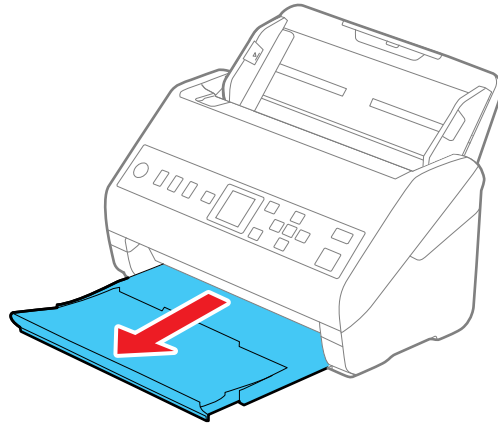

3. Slide the input tray edge guides all the way out.

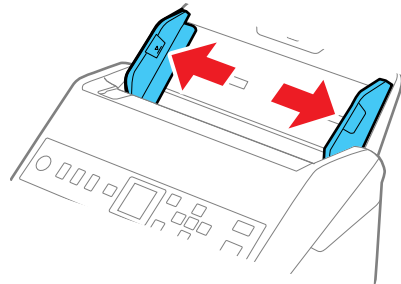

4. Load the originals in the center of the input tray in descending order of paper size with the widest at the back and the narrowest at the front. Slide them in until they meet resistance. Make sure the printed sides are facedown and the top edges are slightly angled in the input tray.

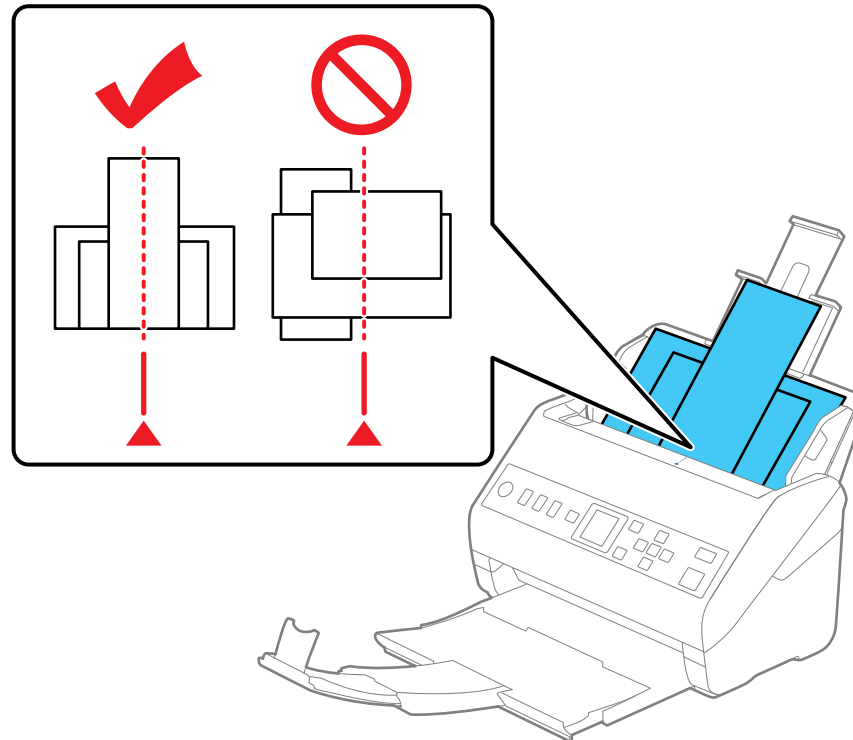

5. Slide the edge guides against the edges of the widest original.
6. If necessary during scanning, adjust the position of the stopper on the output tray extension to fit the ejected originals.

Note: If thicker paper does not eject properly or falls from the output tray, push in the output tray and allow the originals to eject freely onto the surface below the scanner. If the scanned images are affected by the originals ejecting below the scanner, try placing the scanner on the edge of a table where the ejected originals can drop freely.

If scanning thin or wrinkled paper causes paper jams, slow down the feeding speed by selecting **Settings > Scanner Settings > Slow > On** on the LCD screen.

You can also scan originals of multiple sizes by loading them one by one using the **Automatic Feeding Mode** setting in Epson Scan 2.

Parent topic: [Loading Originals in the Input Tray](#)

Original Document Specifications

You can load original documents that meet these specifications in your scanner.

Paper type	Paper size	Paper weight	Loading capacity
Plain paper Fine paper Recycled paper	Letter (8.5 × 11 inches [216 × 279 mm])	7 to 110 lb (27 to 413 g/m ²)	21 lb (80 g/m ²): 100 sheets
	A4 (8.3 × 11.7 inches [210 × 297 mm])		24 lb (90 g/m ²): 86 sheets
	A5 (5.8 × 8.2 inches [148 × 210 mm])		28 lb (104 g/m ²): 74 sheets
	A6 (4.1 × 5.8 inches [105 × 148 mm])		34 lb (127 g/m ²): 62 sheets
	B5 (7.2 × 10.1 inches [182 × 257 mm])		42 lb (157 g/m ²): 50 sheets
	B6 (5 × 7.2 inches [128 × 182 mm])		56 lb (209 g/m ²): 38 sheets
	A8 (2.1 × 2.9 inches [52 × 74 mm])		68 lb (256 g/m ²): 30 sheets
		34 to 110 lb (127 to 413 g/m ²)	110 lb (413 g/m ²): 18 sheets Loading capacity may vary depending on the paper type.
	Width: 2.0 to 8.5 inches (50.8 to 215.9 mm) Height: 15.5 to 240 inches (393.8 to 6096 mm)	13 to 35 lb (50 to 130 g/m ²)	1 sheet

Paper type	Paper size	Paper weight	Loading capacity
Plain paper Fine paper Recycled paper	Legal (8.5 × 14 inches [216 × 356 mm])	7 to 110 lb (27 to 413 g/m ²)	21 lb (80 g/m ²): 80 sheets 24 lb (90 g/m ²): 69 sheets 28 lb (104 g/m ²): 59 sheets 34 lb (127 g/m ²): 50 sheets 42 lb (157 g/m ²): 40 sheets 56 lb (209 g/m ²): 30 sheets 68 lb (256 g/m ²): 24 sheets 110 lb (413 g/m ²): 14 sheets Loading capacity may vary depending on the paper type.
Paper business cards	Business cards	Up to 56 lb (210 g/m ²)	30 cards loaded horizontally

Note: You can load originals of different sizes, paper types, and thicknesses up to this size: Letter (8.5 × 11 inches [216 × 279 mm]).

The following types of originals may not be successfully scanned or may require special attention:

- Originals with uneven surfaces, such as embossed documents or letterhead
- Originals with wrinkles or fold lines
- Perforated originals
- Originals with labels or stickers
- Carbonless paper
- Curled originals
- Coated paper

Note: Lightly wrinkled paper may scan better if you slow down the feeding speed during scanning or smooth out the wrinkles before loading. Use a carrier sheet to scan delicate originals or originals that are easily wrinkled. To scan originals that are incorrectly detected as double feeds, set the **DFDS Function** (Double Feed Detection Skip Function) to **On** on the control panel before you resume scanning, or set the **Detect Double Feed** setting to **Off** on the Main Settings tab in the Epson Scan 2 window.

Caution: Do not load the following types of originals directly in the scanner, or they may be damaged or may damage the scanner:

- Photos
- Originals that are bound
- Passports
- Thermal paper
- Fabric or other non-paper originals
- Originals containing staples or paper clips
- Originals with wet ink or glue
- Ripped originals
- Heavily wrinkled or curled originals
- Originals with holes on the bottom of them
- Transparencies
- Originals with carbon paper backing
- Originals with sticky notes attached
- Glossy originals

Parent topic: [Loading Originals in the Input Tray](#)

Loading Plastic and Laminated Cards in the Input Tray

You can load plastic and laminated cards that meet the card specifications in the input tray.

Note: For best results, make sure Edge Fill is set to **None** in the scanner software.

1. Pull out the output tray and open the stopper. Do not pull out the extensions.

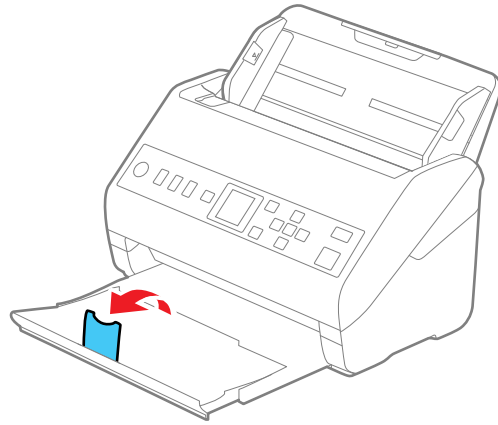

2. Slide the input tray edge guides all the way out.

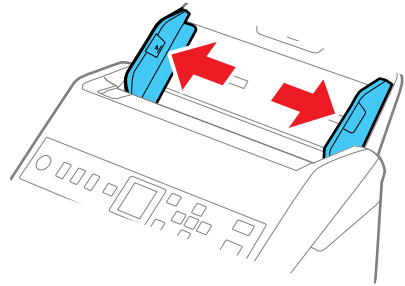

3. Load plastic or laminated cards (printed side down and long edge first) into the input tray horizontally, and slide them in until they meet resistance.

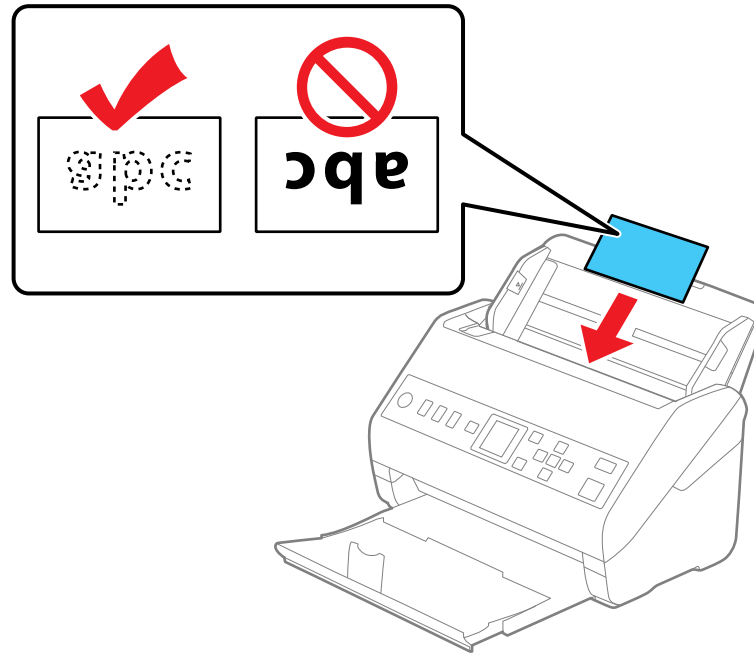

Note: Do not load plastic cards vertically.

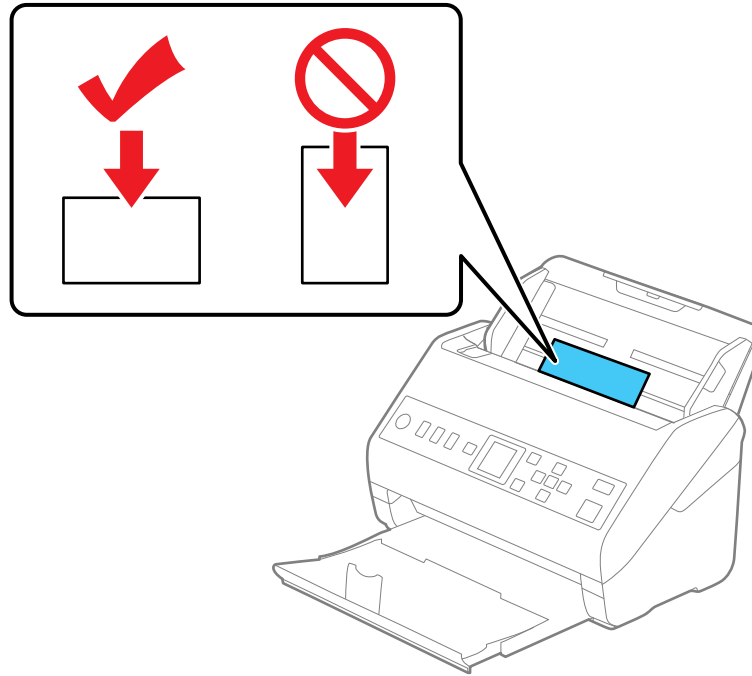

4. Slide the edge guides against the edges of the card.

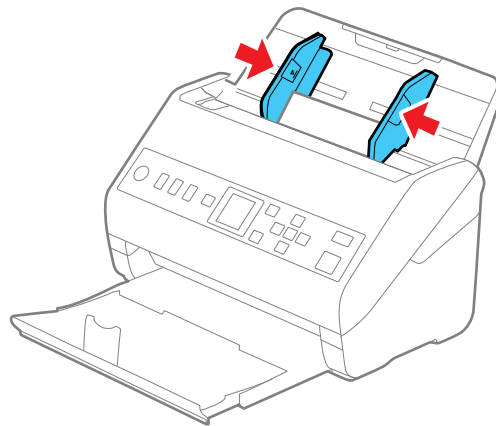

- Turn off the **Detect Double Feed** setting on the Main Settings tab in Epson Scan 2 when scanning the cards.

Note: If you do not disable the **Detect Double Feed** setting and a double feed error occurs, remove the plastic or laminated card from the input tray and reload it. Press the down arrow button on the control panel, and select **DFDS Function > On** to disable the **Detect Double Feed** setting for the next scan. The DFDS Function setting only disables the **Detect Double Feed** setting for one scan.

Plastic and Laminated Card Specifications

Parent topic: [Loading Originals](#)

Plastic and Laminated Card Specifications

You can load original plastic and laminated cards that meet these specifications in your scanner.

Paper type	Paper size	Paper thickness	Loading capacity
Plastic cards, embossed (ISO 7810 ID-1 compliant)	2.1 × 3.3 inches (54 × 85.6 mm)	0.05 inch (1.24 mm) maximum	1 card (horizontal)
Plastic cards, standard (ISO 7810 ID-1 compliant)		0.03 inch (0.76 mm) to 0.04 inch (1.1 mm)*	5 cards (horizontal)
		smaller than 0.03 inch (0.76 mm)	5 cards (horizontal)
Laminated cards	4.7 × 5.9 inches (120 × 150 mm) or smaller	0.03 inch (0.76 mm) maximum	1 card

* Resolution must be 300 dpi or less and slow mode disabled

Note: Plastic cards with glossy surfaces may not scan properly.

Parent topic: [Loading Plastic and Laminated Cards in the Input Tray](#)

Loading Special Originals

You can load photos or large, thick, or folded originals in the input tray using one or more carrier sheets. You can also load envelopes. Make sure the originals meet the specifications for special originals before loading them.

Note: Photos scanned using a document scanner may not have the same color depth as the original. Use a flatbed photo scanner to achieve the best color reproduction of photos.

1. Pull up the input tray extension.
2. Pull out the output tray and its extension, and open the stopper.

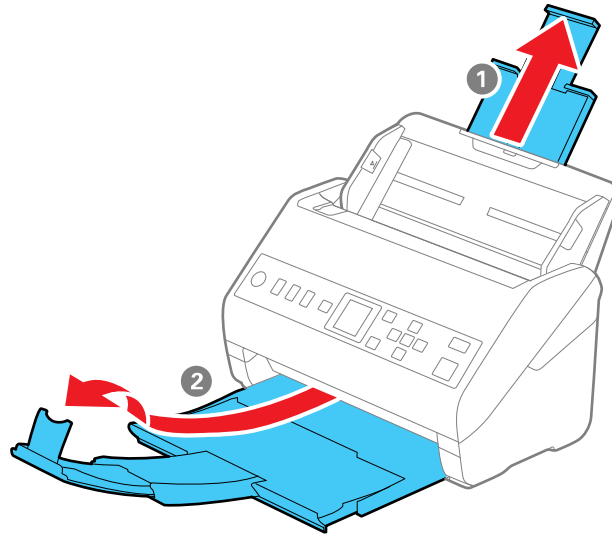

Note: If you are loading originals that are 15.5 inches (393.8 mm) or longer, do not pull out the input or output tray extensions and do not open the stopper.

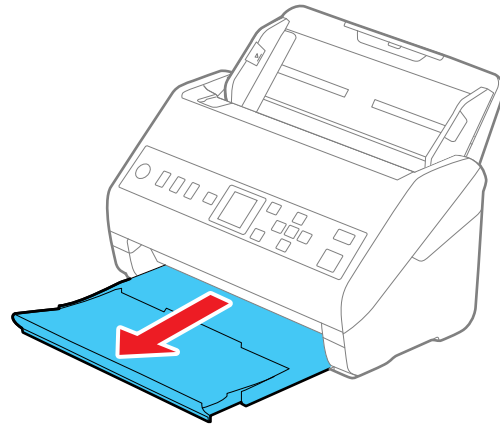

3. Slide the input tray edge guides all the way out.

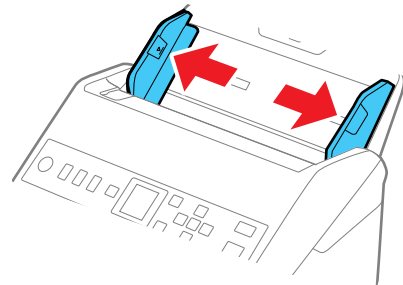

4. Load envelopes vertically in the input tray with the printed side down and the flap facing as shown. Slide in the envelopes until they meet resistance. Skip to step 7.

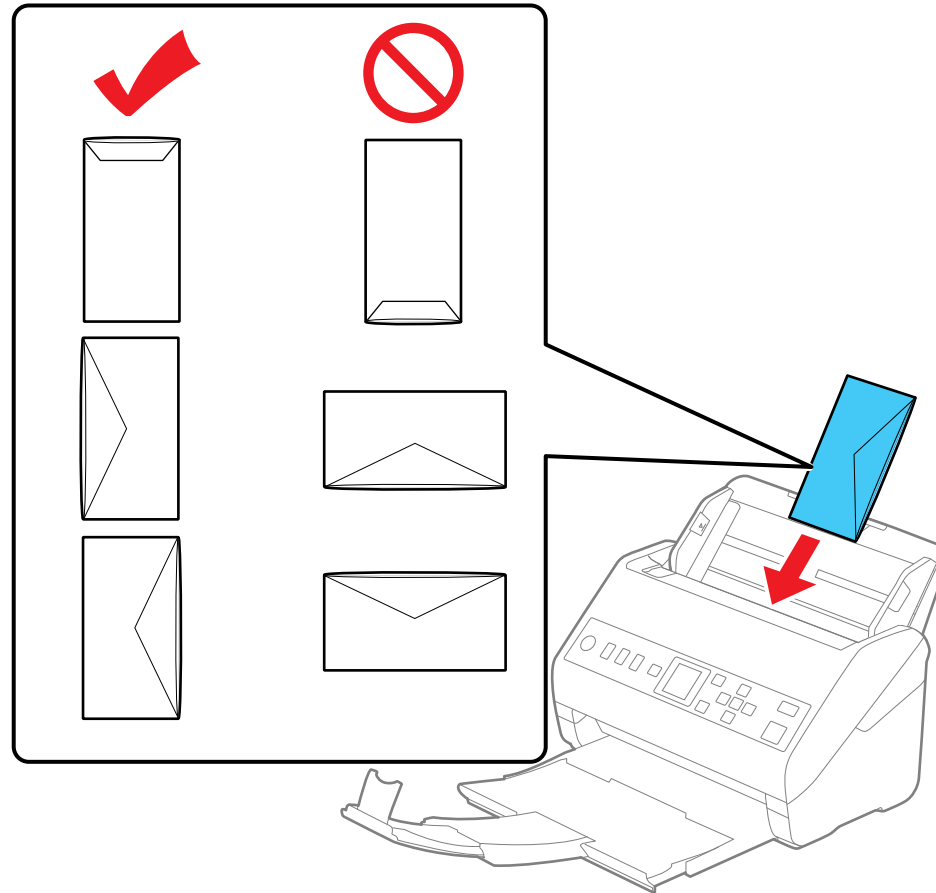

5. Do one of the following to load photos, or folded or irregularly shaped originals using a carrier sheet:

Note: Use only the carrier sheet designed for your scanner. The carrier sheet is automatically recognized by the scanner by the two small rectangular holes on the front edge, as shown. Keep the

holes clean and not covered. Do not load a carrier sheet that has scratches on it or one that has been scanned more than 3,000 times.

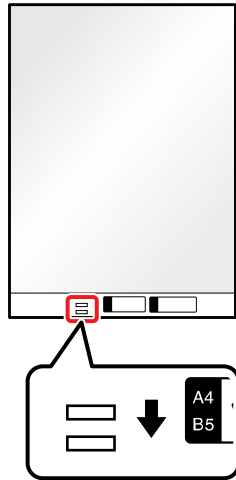

- For a Letter- or A4-size or larger original, fold it as shown and place it in the center of an optional carrier sheet. Make sure the illustration on the front edge of the carrier sheet is facing up.

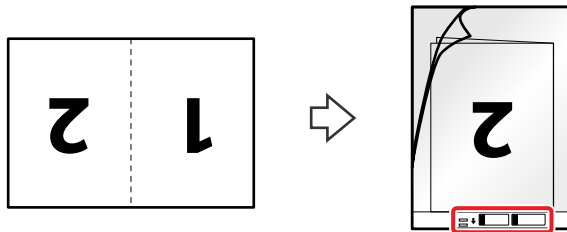

To scan both sides and stitch them together, set the appropriate setting in Epson Scan 2 or Document Capture Pro (Windows).

- For a photo or an irregularly shaped original, load it in the center of an optional carrier sheet with the printed side face down. Make sure the illustration on the front edge of the carrier sheet is facing up. If you are loading originals that are 11.7 inches (297 mm) or shorter, place the leading

edge of the original against the binding of the carrier sheet, as shown. Otherwise, the scanner may not detect the correct length of the original.

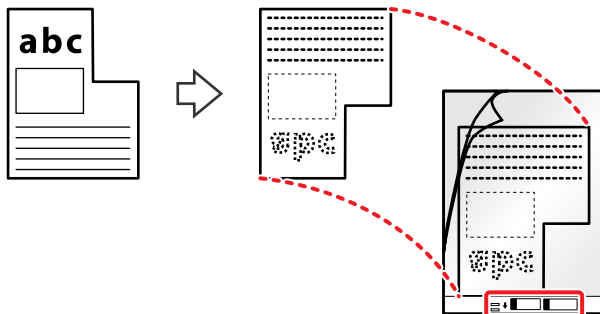

Note: Photos scanned using a document scanner may not have the same color depth as the original. Use a flatbed photo scanner to achieve the best color reproduction of photos.

6. Load the carrier sheet in the input tray as shown until it meets resistance.

Folded original

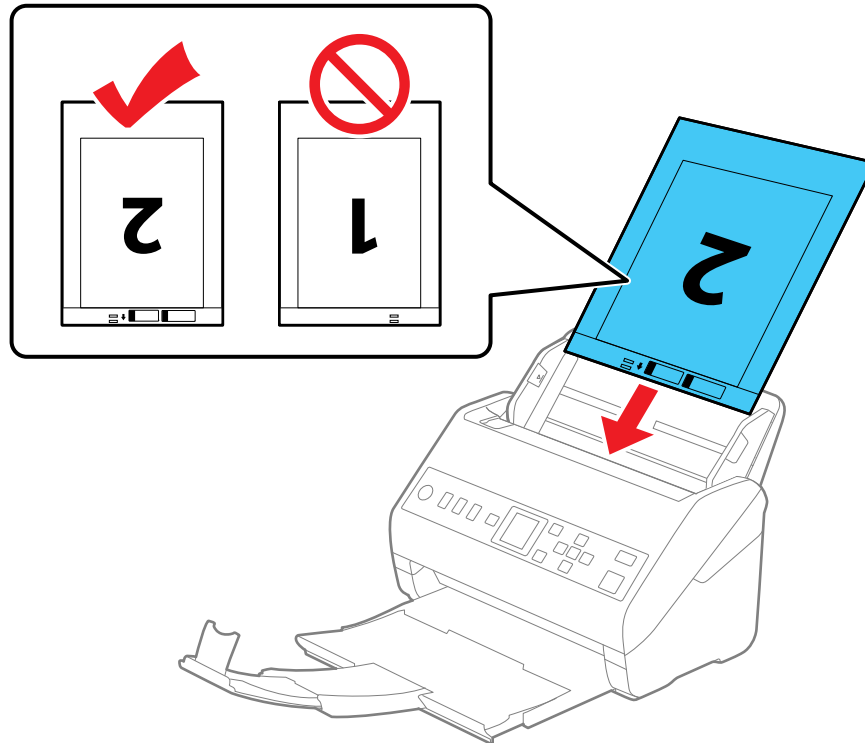
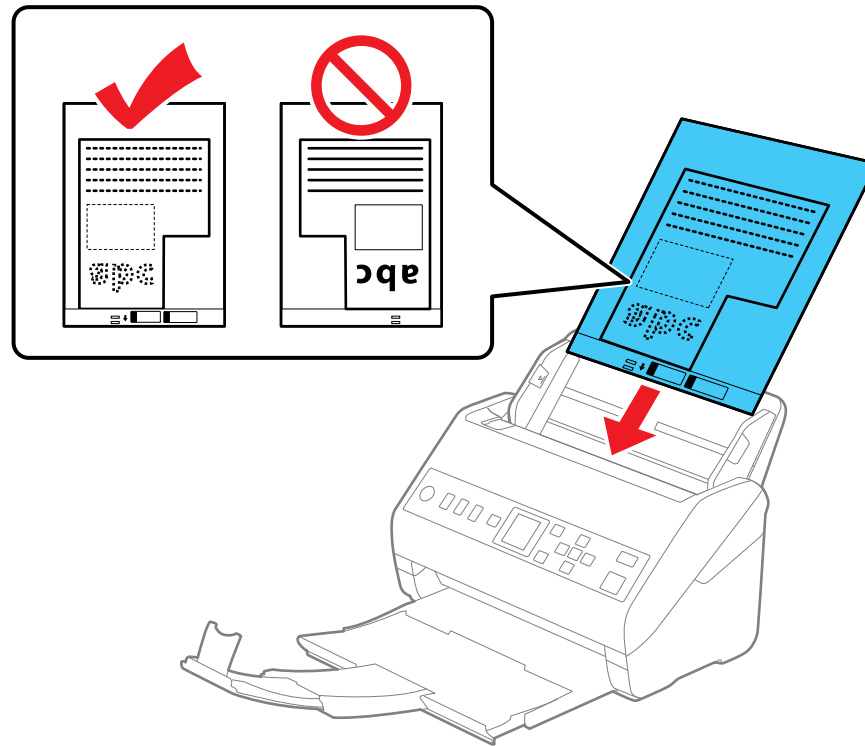
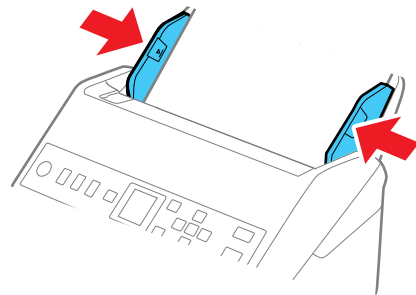

Photo or irregularly shaped original



7. Slide the edge guides against the edges of the envelope or carrier sheet.



8. Turn off the **Detect Double Feed** setting on the Main Settings tab in Epson Scan 2 when scanning special originals.

Note: If the **Document Size** setting on the Main Settings tab in Epson Scan 2 is set to **Auto Detect**, **Paper Skew** is automatically selected as the **Correct Document Skew** setting.

9. If necessary during scanning, adjust the position of the stopper on the output tray extension to fit the ejected originals.

Note: If thicker paper does not eject properly or falls from the output tray, push in the output tray and allow the originals to eject freely onto the surface below the scanner. If the scanned images are affected by the originals ejecting below the scanner, try placing the scanner on the edge of a table where the ejected originals can drop freely.

Special Original Specifications

Parent topic: [Loading Originals](#)

Special Original Specifications

You can load photos, envelopes, or large, thick, or folded originals that meet these specifications in your scanner.

Note: Photos scanned using a document scanner may not have the same color depth as the original. Use a flatbed photo scanner to achieve the best color reproduction of photos.

Paper type	Paper size	Paper thickness	Loading capacity
Large originals (plain paper, fine paper, or recycled paper) (load only in a carrier sheet)	Up to this size: A3 (11.7 × 16.5 inches [297 × 420 mm])	0.012 inch (0.3 mm) maximum (excluding the thickness of the carrier sheet)	10 carrier sheets
Photos (load only in a carrier sheet)	Up to this size: A4 (8.3 × 11.7 inches [210 × 297 mm])	0.012 inch (0.3 mm) maximum (excluding the thickness of the carrier sheet)	10 carrier sheets

Paper type	Paper size	Paper thickness	Loading capacity
Envelopes	4.49 × 6.38 inches (114 × 162 mm) 4.33 × 8.66 inches (110 × 220 mm)	0.015 inch (0.38 mm) maximum	10 envelopes
Irregularly shaped originals (load only in a carrier sheet)	Up to this size: A4 (8.3 × 11.7 inches [210 × 297 mm])	0.012 inch (0.3 mm) maximum (excluding the thickness of the carrier sheet)	10 carrier sheets

Note: Originals that are wider than 8.5 inches (215.9 mm) need to be folded in half.

Parent topic: [Loading Special Originals](#)

Wired Networking

See these sections to use your product on a wired network.

[Network Security Recommendations](#)

[Wired Network Setup](#)

[Connecting the Product to the Network](#)

[Accessing the Web Config Utility](#)

Network Security Recommendations

To help deter unauthorized access to your product over a network, you should protect your network environment using appropriate security measures.

Security measures such as these can help deter threats such as loss of user data, use of telephone and fax lines, and other intrusions:

- **Connect your product only to a network protected by a firewall**

Connecting your product directly to the Internet may leave it vulnerable to security threats. Instead, connect it to a router or other network connection protected by a firewall. Your router may already have a firewall set up by your Internet service provider; check with your ISP for confirmation. For best results, set up and use a private IP address for your network connection.

- **Change the default administrator password on your product**

If your product has an option to set an administrator password, change the default administrator password to deter access by unauthorized users to personal data stored on your product, such as IDs, passwords, and contact lists.

Parent topic: [Wired Networking](#)

Wired Network Setup

You can set up your scanner to communicate with your computer over a wired network by connecting it to the router or hub using an Ethernet cable.

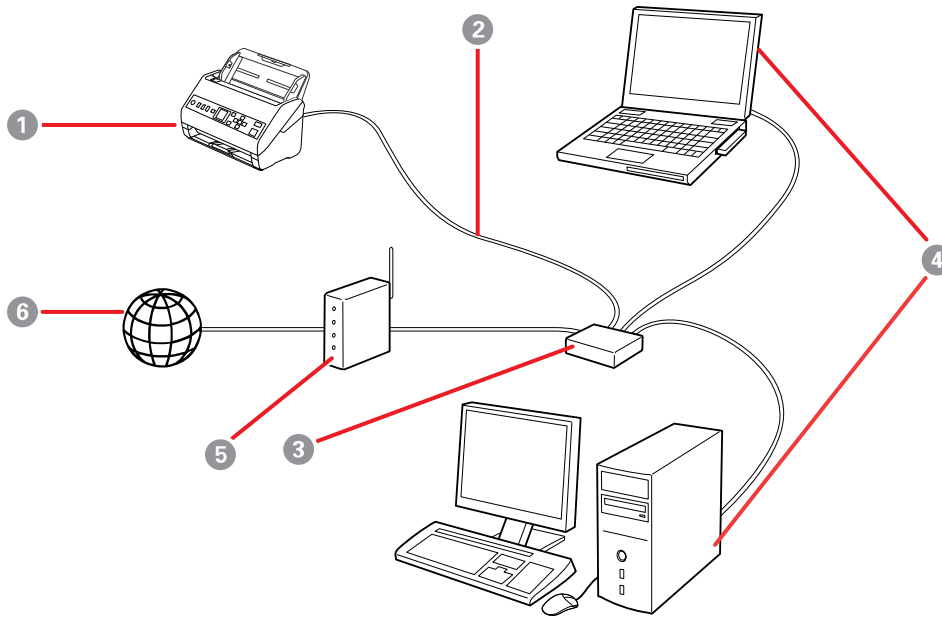

- 1 Epson scanner
- 2 Ethernet cable
- 3 Ethernet hub/switch
- 4 Computers with a wired network interfaces
- 5 Router
- 6 Internet

Parent topic: [Wired Networking](#)

Connecting the Product to the Network

To install your product on a network, follow the instructions on the *Start Here* sheet and install the necessary software by downloading it from the Epson website. The installer program guides you through network setup. You can check the network status using your product's control panel.



1. Press the  home button, if necessary.
2. Use the arrow buttons to select **Settings** and press **OK**.
3. Use the arrow buttons to select **Network Status** and press **OK**.

[Determining the Scanner's IP Address](#)

Parent topic: [Wired Networking](#)

Determining the Scanner's IP Address

If you have multiple scanners on your network, you need to know the IP address of the scanner when setting up network scanning.

1. Do one of the following to start EpsonNet Config:
 - **Windows 10:** Click  > **EpsonNet** > **EpsonNet Config**.
 - **Windows 8.x:** Navigate to the **Apps** screen and select **EpsonNet Config**.
 - **Windows (other versions):** Click  or **Start**, and select **All Programs** or **Programs**. Select **EpsonNet** > **EpsonNet Config** > **EpsonNet Config**.
 - **Mac:** Open the **Applications** folder and select **Epson Software** > **EpsonNet** > **EpsonNet Config** > **EpsonNet Config**.
2. Locate your scanner in the list and write down the IP address.

Parent topic: [Connecting the Product to the Network](#)

Accessing the Web Config Utility

You can select your product's network settings and confirm its operating status using a web browser. You do this by accessing your product's built-in Web Config utility from a computer or other device that is connected to the same network as your product.

Note: For more information on administration settings, see the [Administrator's Guide](#).

1. Check your network status.
2. Note your product's IP address.
3. On a computer or other device connected to the same network as your product, open a web browser.
4. Enter your product's IP address into the address bar.

You see the available Web Config utility options.

[Registering Presets or Quick Send Buttons](#)

Parent topic: [Wired Networking](#)

Registering Presets or Quick Send Buttons

You can register up to 12 frequently used scanning settings as Presets. Settings registered to preset numbers 1 through 3 are assigned to the  Quick Send buttons on the product.

Note: For more information on administration settings, see the [Administrator's Guide](#).

1. Access the Web Config Utility
2. Login as an administrator to change the scanner settings.

Note: If **Administrator Logout** is displayed at the top-right of the screen, you are already logged in as an administrator.

3. Select **Presets** on the Scan tab.
4. Select the Presets number you want to configure, and click **Edit**.
5. Select **Type**, and click **Next**.
6. Enter the name you want to display, and then click **Select from Contacts** or **Enter Destination** to set the destination information. You can enter the email address manually to add to the destination.
7. Select the scan settings, as necessary.
8. Click **OK** to apply the settings.

Parent topic: [Accessing the Web Config Utility](#)

Scanning

You can scan your originals and save them as digital files.

[Starting a Scan](#)

[Scanning with Simple Scan in Document Capture Pro - Windows](#)

[Scanning with Job Scan in Document Capture Pro - Windows](#)

[Scanning with Document Capture - Mac](#)

[Scanning in Epson Scan 2](#)

[Scan Resolution Guidelines](#)

[Scanning Special Projects](#)

Starting a Scan

After placing your originals on your product for scanning, start scanning using one of these methods.

Note: You can also scan using Document Capture Pro (Windows) or Document Capture (Mac).

[Scanning Using the Product Control Panel](#)

[Starting a Scan Using the Epson Scan 2 Icon](#)

[Starting a Scan from a Scanning Program](#)

Parent topic: [Scanning](#)

Scanning Using the Product Control Panel

You can use the following methods to save scanned images from the product's control panel.

- **Quick Send buttons or Presets**

You can save the scanned image to a network folder, or send the image by e-mail using the  Quick Send buttons or Presets. (You can configure the settings in Web Config.)

- **Computer**

You can save the scanned image to a computer connected to the scanner.

- **Web Services for Devices (WSD)**

You can use the WSD feature to save the scanned image to a computer connected to the scanner.

[Setting the Operation Mode on the Product Control Panel](#)

[Scanning Using the Quick Send Buttons](#)

[Scanning Using Presets](#)

[Scanning Originals to the Computer](#)

[Scanning Using Web Services for Devices \(WSD\) - Windows](#)

[Adding and Assigning Scan Jobs with Document Capture Pro - Windows](#)

[Adding and Assigning Scan Jobs with Document Capture - Mac](#)

Parent topic: [Starting a Scan](#)

Setting the Operation Mode on the Product Control Panel

Before scanning, set the operation mode on the control panel.

1. Make sure you installed the product software and connected the product to your computer or network.
2. Press the  home button, if necessary.
3. Use the arrow buttons to select **Settings** and press **OK**.
4. Select **Document Capture Pro** and press **OK**.
5. Select **Operation Mode** and press **OK**.
6. Choose from the following options:
 - Select **Client Mode** if your product is connected to the network with Document Capture Pro or Document Capture software running on a Windows or macOS Client PC.
 - Select **Server Mode** if your product is connected to the network with Document Capture Pro Server (DCPS) running on a Microsoft-based Server OS. You need to enter the server address in this mode.
7. Press **OK** to return to the Settings menu.

Parent topic: [Scanning Using the Product Control Panel](#)

Scanning Using the Quick Send Buttons

You can use the  Quick Send buttons to save the scanned image to a network folder, or send the image by email using pre-configured settings.

1. Make sure you installed the product software and connected the product to your computer or network.
2. Place your original on the product for scanning.
3. Press any of the  Quick Send buttons.

The **Quick Send** screen is displayed, and configured destinations are listed.



Note: You can also display the Quick Send screen by selecting **Quick Send** on the home screen.

4. Press the  Quick Send button for the destination to which you want to send your scans.

Parent topic: [Scanning Using the Product Control Panel](#)

Scanning Using Presets

You can register up to 12 frequently used scanning settings and use them to scan images.

1. Make sure you installed the product software and connected the product to your computer or network.
2. Place your original on the product for scanning.
3. Press the  home button, if necessary.
4. Use the arrow buttons to select **Preset** and press **OK**.
5. Use the arrow buttons to select the preset you want to use and press **OK**.
6. Press the  start button to start scanning using the selected preset.

Parent topic: [Scanning Using the Product Control Panel](#)

Scanning Originals to the Computer

You can scan an original from the control panel using jobs created in Document Capture Pro or Document Capture. Set the operation mode on the control panel before scanning.

1. Make sure you installed the product software and connected the product to your computer or network.

Note: Restart your computer after installing the product software to enable scanning from the control panel.

2. Place your original on the product for scanning.
3. Press the  home button, if necessary.
4. Use the arrow buttons to select **Computer** and press **OK**.
5. Select the computer on which you created the jobs in Document Capture Pro or Document Capture.

Note: If the scanner is connected via USB or the operation mode is set to **Server**, you do not need to select a computer.

6. On the **Select Job** screen, use the arrow buttons to select the job you want to use.
7. If you want to change the scan settings, press the down arrow and use the arrow buttons to select from the following options:
 - To slow down the scanning speed, set the **Slow** setting to **On**.
 - To skip double feed detection when scanning originals such as envelopes or plastic cards, set the **DFDS Function** setting to **On**.
 - To stop scanning when a double feed is detected, select **Double Feed Stop Timing** and press **OK**. Use the arrow buttons to select a timing option.
 - To stop scanning when a paper feed error is detected or the original is fed askew, select **Paper Protection** and press **OK**. Use the arrow buttons to select the setting you want to use.

Note: Turning this function on will not always prevent damage to your originals.

- To detect dirt on the glass surface inside the product, select **Detect Glass Dirt** and press **OK**. Use the arrow buttons to select the setting you want to use.
- To detect a double feed error when scanning multiple originals, set the **Ultrasonic Double Feed Detection** setting to **On**.
- To set a timeout when using the Automatic Feeding Mode, select **Automatic Feeding Mode Timeout** and select the settings you want to use.

Note: This setting is available when you scan from the Quick Send buttons or Presets.

8. Press the **OK** button to view the job settings.
9. Use the arrow buttons to scroll through the job settings and make any desired changes.

Note: If **Disable job setting changes on control panel** is set to **On** in Document Capture Pro or Document Capture, you cannot change the settings.



10. Press the  start button to start scanning.

Parent topic: [Scanning Using the Product Control Panel](#)

Scanning Using Web Services for Devices (WSD) - Windows

You can scan originals to a computer from the product control panel using WSD (Web Services for Devices). The **Computer (WSD)** function lets you manage network scanning in Windows 10, Windows 8.x, or Windows 7.

Note: To use this feature on Windows 7, you must first set up WSD on the computer. See Windows help for instructions.

1. Make sure you installed the product software and connected the product to your computer or network.
2. Place your original on the product for scanning.
3. Press the  home button, if necessary.
4. Use the arrow buttons to select **WSD** and press **OK**.
5. Select a computer.
6. Press the  start button to start scanning.



The scanned image is transferred to the selected computer.

Parent topic: [Scanning Using the Product Control Panel](#)

Adding and Assigning Scan Jobs with Document Capture Pro - Windows

You can add scan jobs that contain specific scan settings and use the jobs when you scan from your product control panel or the Job Scan option in Document Capture Pro. You can save up to 30 scan jobs.

Note: Settings may vary depending on the software version you are using. Click the **Help** icon in Document Capture Pro at any time for more information.

1. Do one of the following to start Document Capture Pro:
 - **Windows 10:** Click  and select **Epson Software > Document Capture Pro**.
 - **Windows 8.x:** Navigate to the **Apps** screen and select **Document Capture Pro**.
 - **Windows (other versions):** Click  or **Start**, and select **All Programs** or **Programs**. Select **Epson Software > Document Capture Pro**.

You see the Document Capture Pro window.

2. Select the **Job Scan** tab.

You see a window like this:

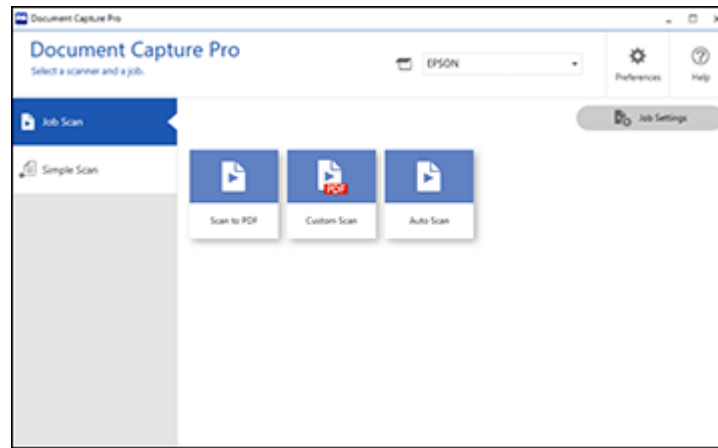

3. Click the **Job Settings** button.

You see a window like this:

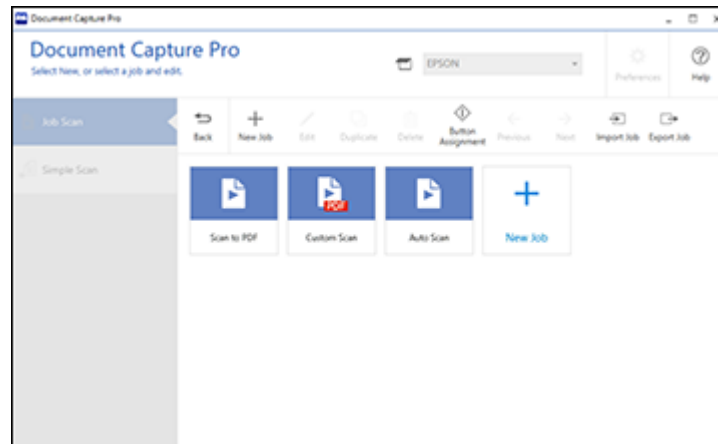

4. To add a scan job, click the **New Job** icon.

5. Enter a name for the new job, and select any settings as necessary from the following options:
 - **Scan**: select the size, color, or resolution
 - **Save**: select the file name, file type, or destination folder
 - **Index**: enable the index setting and choose output options for an index file
 - **Send**: select the destination for the scanned file, or choose to email or print the file
 - **Confirm/Test**: select the job button icon and color, choose display settings, and run a test scan if necessary
6. Click **Save** when you are finished.
The new job appears in the Job Scan window.
7. To assign a scan job to the product control panel, click the **Button Assignment** icon.
You see a screen like this:

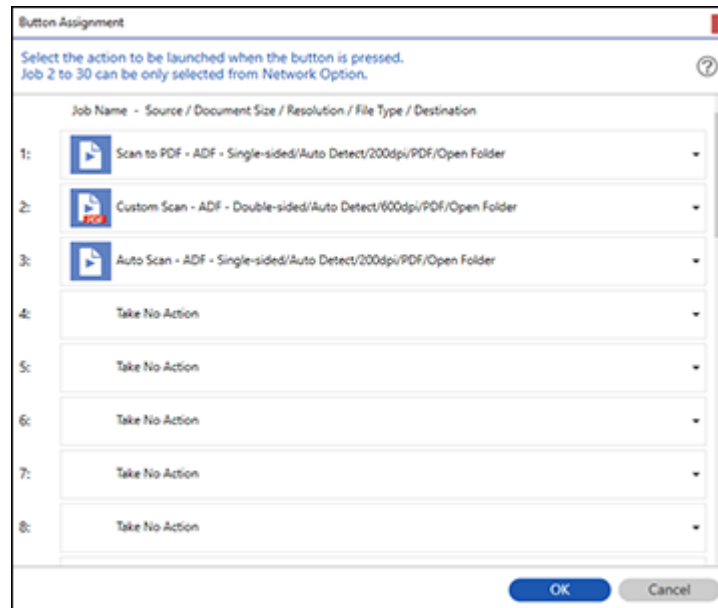

8. Select the jobs that you want to assign to the product control panel using any of the pull-down menus.

Note: The number of pull-down menus available may vary, depending on your product and any connected options.

9. Click **OK**, then click **Back**.



You can now use the added scan jobs when you scan from the product control panel.

Parent topic: [Scanning Using the Product Control Panel](#)

Adding and Assigning Scan Jobs with Document Capture - Mac

You can add scan jobs that contain specific scan settings and use the jobs when you scan from your product control panel or Document Capture. You can save up to 30 scan jobs.

Note: Settings may vary depending on the software version you are using. See the **Help** menu in Document Capture at any time for more information.

1. Start Document Capture on a computer connected to the product.
2. Click the  Manage Job icon from the toolbar at the top of the window.
You see a window showing the current scan job list.
3. To add a scan job, click the **+** icon, enter a name for the new job, select settings as necessary, and click **OK**.
You can now use the new scan job when you scan with Document Capture.
4. To assign a scan job to the product control panel, click the  settings icon at the bottom of the window and click **Event Settings**.
5. Select the jobs that you want to assign to the product control panel using any of the pull-down menus.

Note: The number of pull-down menus available may vary, depending on your product and any connected options.

6. Click **OK**, then click **OK** again.



You can now use the added scan jobs when you scan from the product control panel.

Parent topic: [Scanning Using the Product Control Panel](#)

Starting a Scan Using the Epson Scan 2 Icon

You can start the Epson Scan 2 program to select scan settings, scan, and save the scanned image to a file.

Note: If you are using your Epson product with the Windows 10 S operating system, you cannot use the software described in this section. You also cannot download and install any Epson product software from the Epson website for use with Windows 10 S; you must obtain software only from the Windows Store.

- **Windows 10:** Click  and select **EPSON > Epson Scan 2**.
- **Windows 8.x:** Navigate to the **Apps** screen and select **Epson Scan 2**.
- **Windows (other versions):** Click  or **Start**, and select **All Programs** or **Programs**. Select **EPSON > Epson Scan 2 > Epson Scan 2**.
- **Mac:** Open the **Applications** folder, open the **Epson Software** folder, and select **Epson Scan 2**.

You see an Epson Scan 2 window like this:

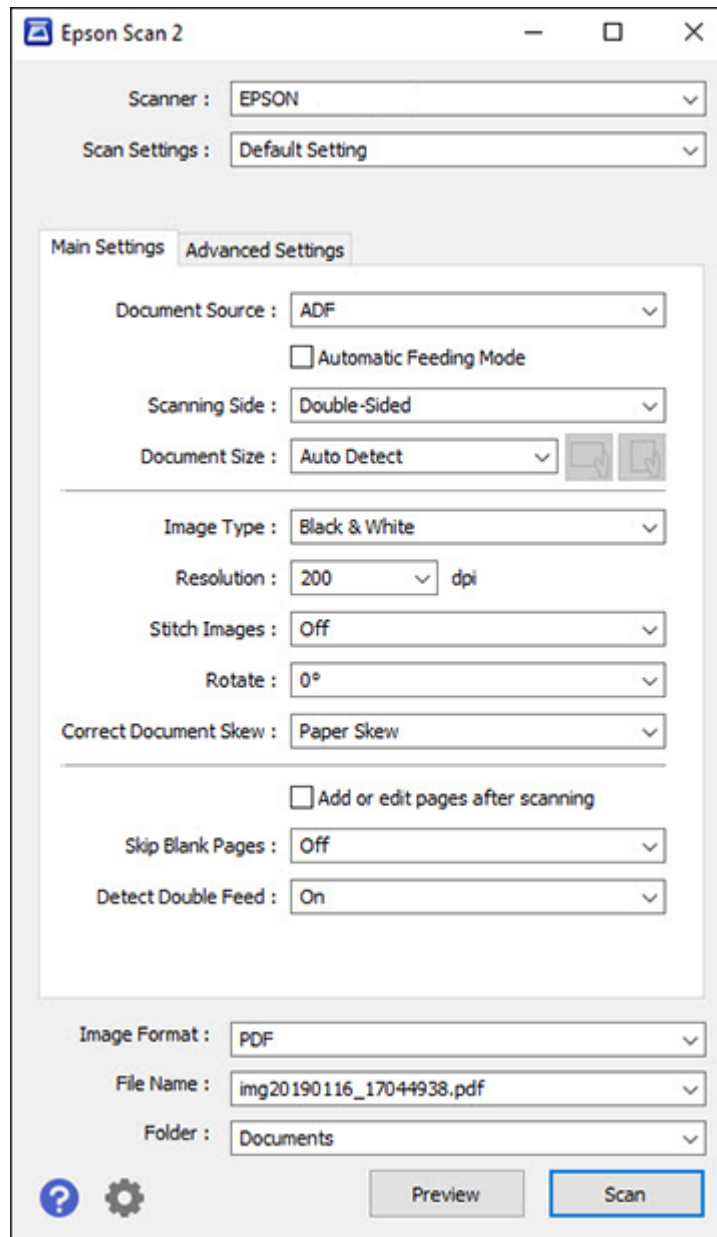

Parent topic: [Starting a Scan](#)

Starting a Scan from a Scanning Program

You can start Epson Scan 2 from a TWAIN-compliant scanning program to select scan settings, scan, and open the scanned image in the program.

Note: If you are using your Epson product with the Windows 10 S operating system, you cannot use the software described in this section. You also cannot download and install any Epson product software from the Epson website for use with Windows 10 S; you must obtain software only from the Windows Store.

1. Open your scanning program and select its scanning option. (See your scanning program help for instructions.)
2. Select your product.

Note: In certain programs, you may need to select your product as the "source" first. If you see a **Select Source** option, choose it and select your product. With Windows, do not select a **WIA** option for your product; not all scan functions will be available.

You see an Epson Scan 2 window like this:

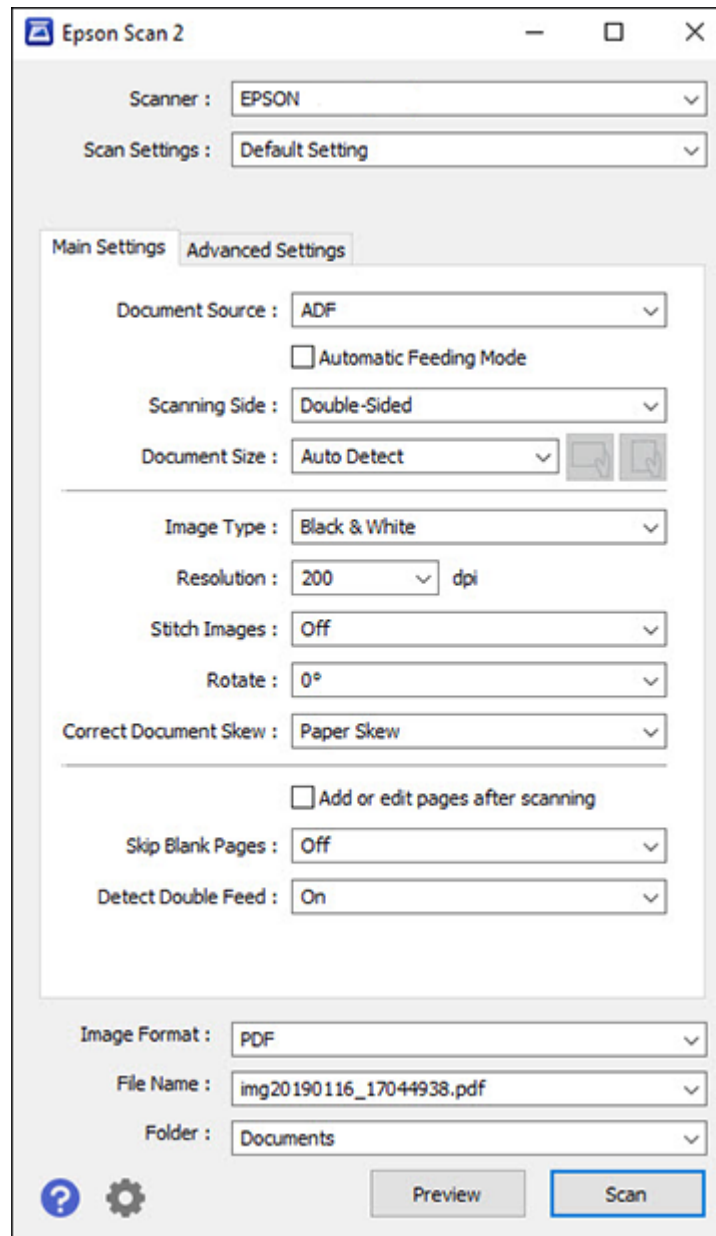



Parent topic: [Starting a Scan](#)

Scanning with Simple Scan in Document Capture Pro - Windows

You can use the Simple Scan option in Document Capture Pro to quickly scan an original.

Note: Settings may vary depending on the software version you are using. Click the **Help** icon in Document Capture Pro at any time for more information.

1. Load your original in the product.
2. Do one of the following to start Document Capture Pro:
 - **Windows 10:** Click  and select **Epson Software > Document Capture Pro**.
 - **Windows 8.x:** Navigate to the **Apps** screen and select **Document Capture Pro**.
 - **Windows (other versions):** Click  or **Start**, and select **All Programs** or **Programs**. Select **Epson Software > Document Capture Pro**.

You see the Document Capture Pro window.

Note: You may need to select your scanner from the list, if necessary.

3. Select the **Simple Scan** tab.

You see a window like this:

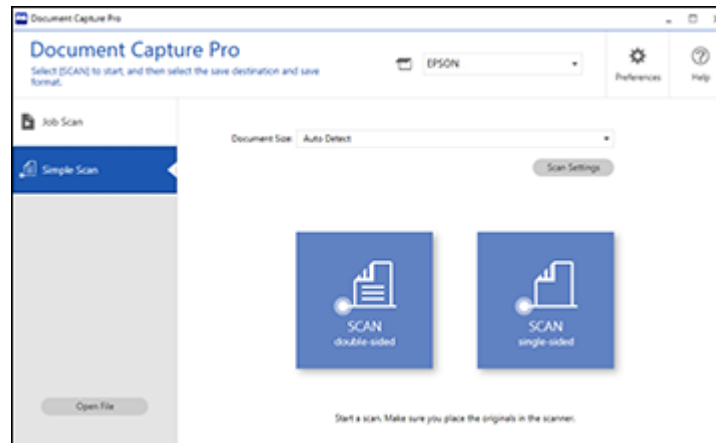

4. Select the size of your original from the **Document Size** menu.
5. If you want to change specific settings for the scan, click the **Scan Settings** button. Change any of the settings as necessary and click **OK**. For additional settings, click the **Detailed Settings** button on the Scan Settings screen.
6. Do one of the following:
 - To scan the front side of an original, select **SCAN single-sided**.
 - To scan both sides of an original, select **SCAN double-sided**.Your product scans the original and the image appears in the Edit Scanned Results window.
7. Review and edit the scanned image as necessary and click **Next** when you are finished.
8. Select a destination for the scanned image, change any settings as necessary, and click **Complete**.



Note: If you are sending the scanned image to a server or cloud destination, you need to enter your login information.

Parent topic: [Scanning](#)

Scanning with Job Scan in Document Capture Pro - Windows

You can create scan jobs in Document Capture Pro and use them to quickly scan originals and save them to various destinations.

Note: Settings may vary depending on the software version you are using. Click the **Help** icon in Document Capture Pro at any time for more information.

1. Load your original in the product.
2. Do one of the following to start Document Capture Pro:
 - **Windows 10:** Click  and select **Epson Software > Document Capture Pro**.
 - **Windows 8.x:** Navigate to the **Apps** screen and select **Document Capture Pro**.
 - **Windows (other versions):** Click  or **Start**, and select **All Programs** or **Programs**. Select **Epson Software > Document Capture Pro**.

You see the Document Capture Pro window.

Note: You may need to select your scanner from the list, if necessary.

3. Select the **Job Scan** tab.
You see a window like this:

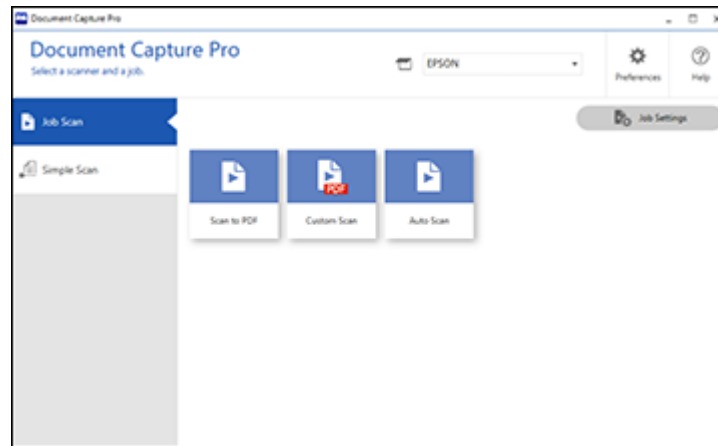

4. Select one of the scan jobs (or click **Job Settings** to create a new scan job).
The product scans the loaded original and saves it according to the job settings.
5. Depending on the settings for the scan job you selected, you may be able to view and edit the pages before saving them. If so, click **Complete** when finished.
The scanned image is saved according to the job settings.

Parent topic: [Scanning](#)

Scanning with Document Capture - Mac

When you scan with Document Capture, the program automatically saves your scanned file on your computer in the folder you specify. You can select settings, preview, and change the scanned file settings as necessary.

Note: Settings may vary depending on the software version you are using. See the **Help** menu in Document Capture at any time for more information.

1. Load your original in the product.
2. Open the **Applications** folder, open the **Epson Software** folder, and select **Document Capture**.

You see a window like this:

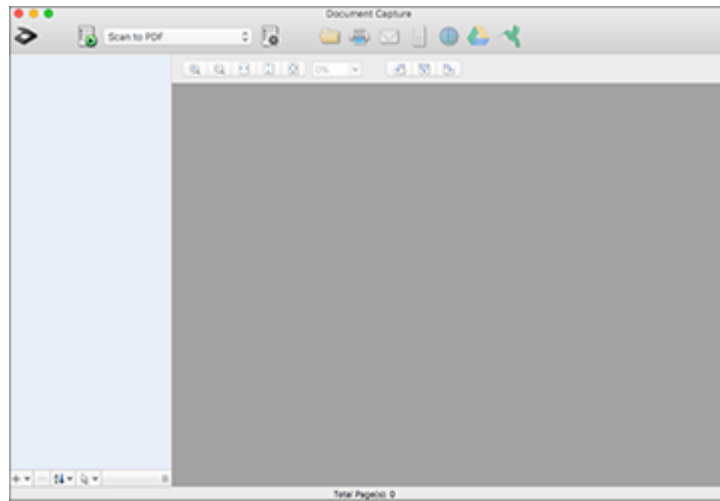

Note: You may need to select your scanner from the scanner list.

3. Click the  scan icon.

You see a window like this:

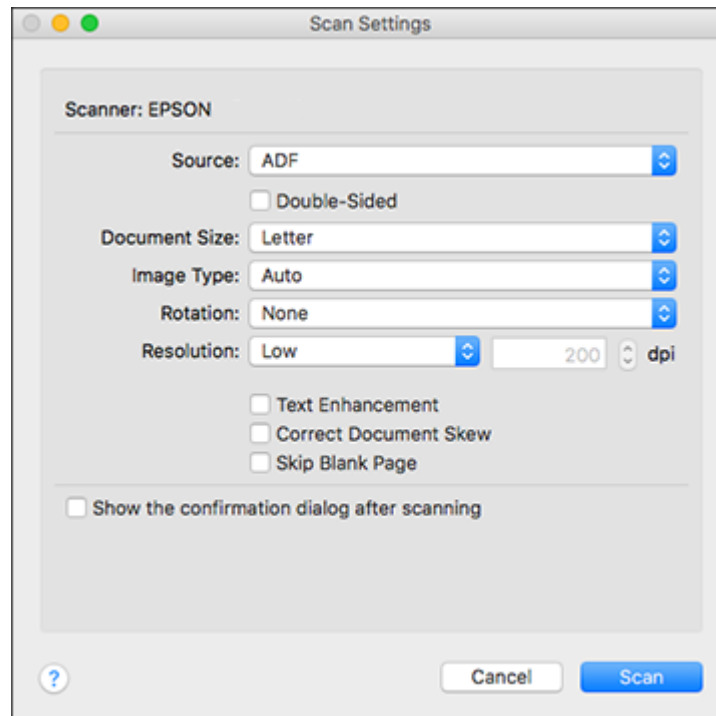

Note: If you want to use a scan job that you created instead, select it from the Job list in the Document Capture window, click the  Start Job button, and skip the rest of these steps.

4. Select any displayed scan settings you want to use.

Note: See the Help information in Document Capture for details.

5. If you want to select detailed scan settings, close the Scan Settings window, open the **Scan** menu at the top of the Mac desktop, and select **Displays the EPSON Scan Setup Screen**.
6. Click the  Scan icon and select any detailed scan settings you want to use from the Epson Scan 2 window.
7. Click **Scan**.

You see a preview of your scan in the Document Capture window.

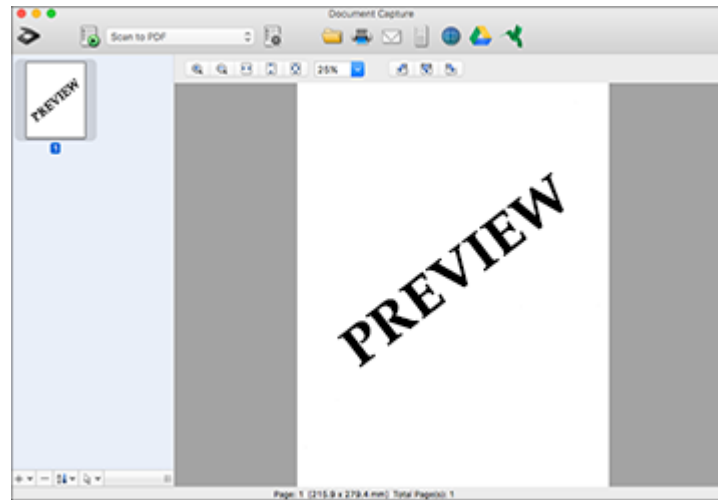

Note: You may have to close the Epson Scan 2 window to view your scan in the Document Capture window.

8. If you would like to scan additional originals and add them to the current captured images, click the + icon, select **Acquire from Scanner**, and repeat the previous steps.
9. Check the scanned images and edit them as necessary.
10. Click one of the destination icons to choose where to send your scanned files. (If you cannot see all of the icons below, click the arrow next to the icons.) Change any settings as necessary.



Note: If you are sending the scanned image to a server or cloud destination, you need to enter your login information.

11. Depending on the destination you chose, click **OK** or **Send** to complete the operation.

Parent topic: [Scanning](#)

Related tasks

[Loading Originals in the Input Tray](#)

[Scanning in Epson Scan 2](#)

Scanning in Epson Scan 2

Epson Scan 2 gives you access to basic and advanced scanning features. You can scan your document and save the scanned image in various file formats in your operating system's Documents or My Documents folder, or open it in your scanning program. You can preview the scanned image and select or change settings as necessary.

1. Load your original in the product.
2. Start Epson Scan 2.

You see this window:

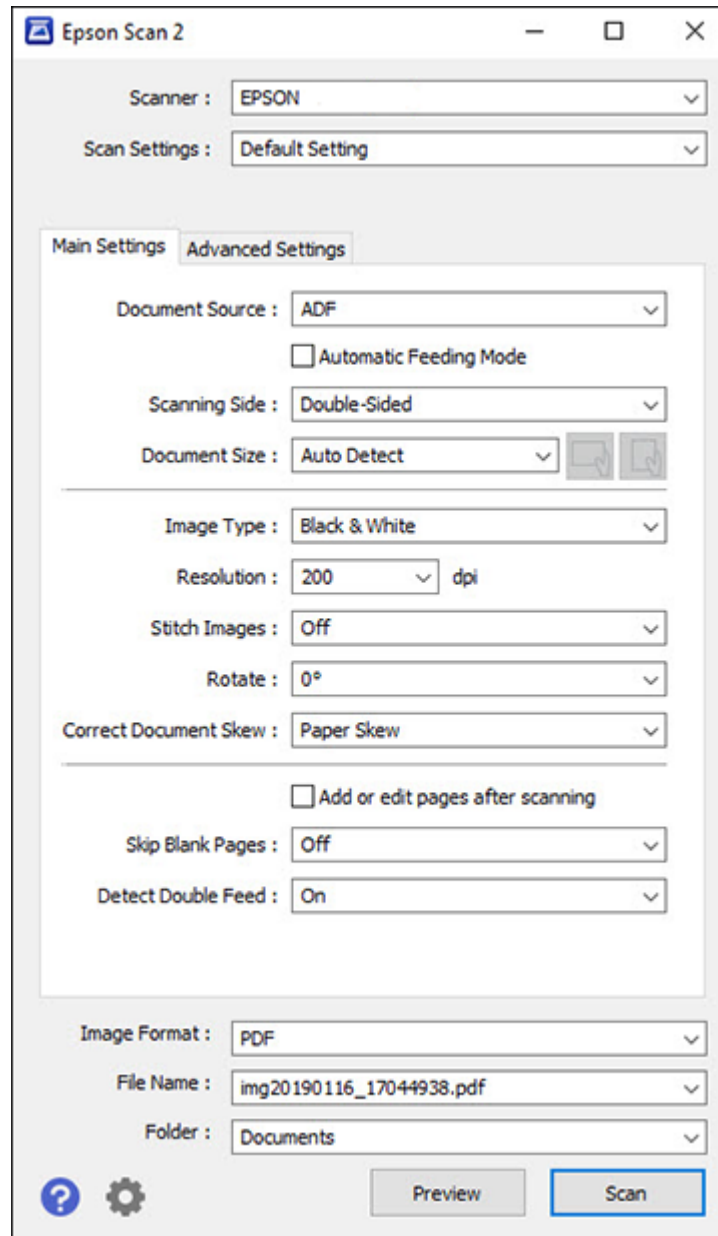

Note: The **Document Source** setting is automatically set to **ADF** for your product.

3. If you want to scan different size originals by loading them into the ADF one by one, check the **Automatic Feeding Mode** checkbox and click **Scan**. Scanning begins as soon as you load each original.
4. Select the **Scanning Side** setting that matches the sides of the original that you want to scan.
5. Select the **Document Size** setting that matches the size of your original, or select **Auto Detect** to have Epson Scan 2 automatically detect the size. You can select **Customize** to enter a custom size, if necessary.
6. Click on one of the orientation icons, if applicable.
7. Select your original image type and how you want it scanned as the **Image Type** setting, or select **Auto** to have Epson Scan 2 automatically detect the image type.
8. Select the **Resolution** setting you want to use for your scan.
9. Select any of the additional settings that you want to use on the **Main Settings** tab.
10. Click the **Advanced Settings** tab and select any settings that you want to use.
11. To see a preview of your scan with the settings you selected, click the **Preview** button.

Epson Scan 2 previews your original and displays the results in the Epson Scan 2 window.

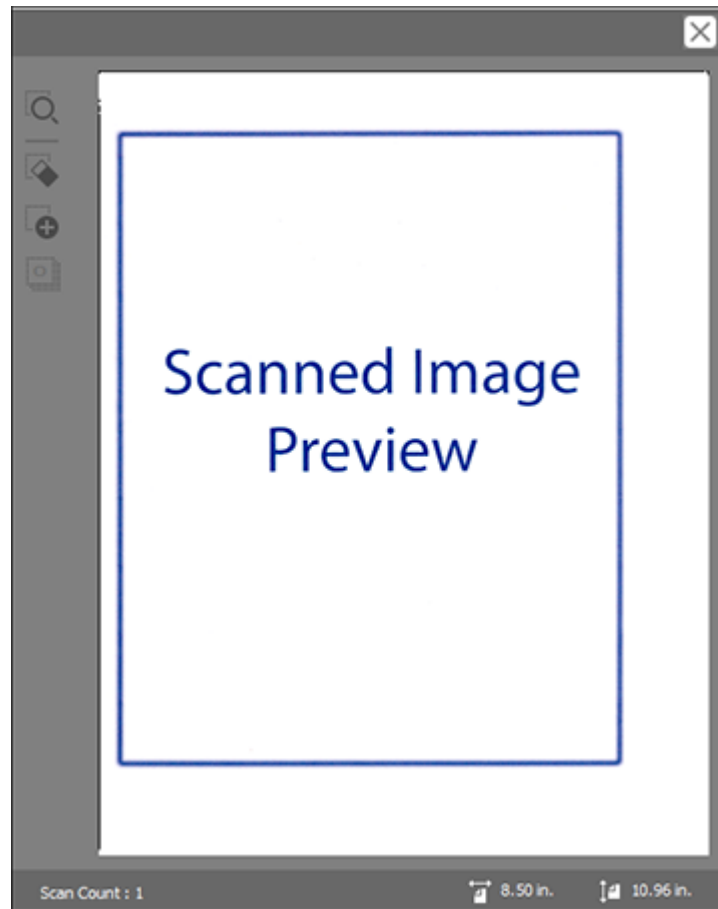

12. Reinsert your original into the ADF.
13. If scanning an original in a carrier sheet or other special original, see the link below for other setting requirements for special documents.
14. Select the format in which you want to save your scanned file as the **Image Format** setting. If necessary, select **Options** and select any desired format options.
15. Select **Settings** to modify the file name settings. Enter the file name for your scanned file in the **File Name** field.

16. Select the location in which you want to save your scanned file as the **Folder** setting. If necessary, select **Select** to choose an alternate folder or create a new folder.
17. Click **Scan**.
The product scans your original and saves the scanned file in the location you specified.
18. If you selected the **Automatic Feeding Mode** setting, place your next original in the ADF for scanning. When you finish scanning originals, click **Finish**.

[Additional Scanning Settings - Main Settings Tab](#)

[Additional Scanning Settings - Advanced Settings Tab](#)

[Scanning Settings for Special Documents](#)

[Image Format Options](#)

Parent topic: [Scanning](#)

Related tasks

[Loading Originals in the Input Tray](#)

Additional Scanning Settings - Main Settings Tab

You can select these additional scanning settings on the Epson Scan 2 Main Settings tab.

Stitch Images

When scanning double-sided originals, lets you lay out images from both sides of the original onto one scanned page.

Rotate

Rotates the original image clockwise to the desired angle before scanning it. Select **Auto** to allow your product to automatically rotate the image based on the orientation of the text (may take longer to scan).

Correct Document Skew

Corrects skewed originals, image contents, or both.

Add or edit pages after scanning

Lets you add, remove, or edit the pages in a scan, including rotating pages and changing the page order.

Note: To save multiple pages in a single file, you must select a file format that supports multiple pages such as **PDF** or **Multi-TIFF**. If you select another file format, each scanned image or page is saved as a separate file.

Skip Blank Pages

If the scanner detects marks from the other side of a blank page and adds the marks to the scanned image, adjust this setting to prevent this.

Detect Double Feed

Detects a double-feed paper error in the ADF. If you are scanning an original envelope or plastic card, select **Off**.

Parent topic: [Scanning in Epson Scan 2](#)

Additional Scanning Settings - Advanced Settings Tab

You can select these additional scanning settings on the Epson Scan 2 Advanced Settings tab. Not all adjustment settings may be available, depending on other settings you have chosen.

Unsharp Mask

Makes the edges of certain image areas clearer. Turn off this option to leave softer edges.

Descreening

Removes the ripple pattern that might appear in subtly shaded image areas, such as skin tones. This option improves results when scanning magazines or newspapers. (The results of descreening do not appear in the preview image, only in your scanned image.)

Remove Background

Removes the background of the originals.

Text Enhancement

Sharpens the appearance of letters in text documents.

Auto Area Segmentation

Makes black and white images clearer and text recognition more accurate by separating the text from the graphics.

Dropout

The scan will not pick up the color you select. This setting is available only if you select **Grayscale** or **Black & White** as the Image Type setting.

Color Enhance

Enhances the shades of the color you select in the scanned image. This setting is available only if you select **Grayscale** or **Black & White** as the Image Type setting.

Brightness

Adjusts the overall lightness and darkness of the scanned image.

Contrast

Adjusts the difference between the light and dark areas of the overall scanned image.

Gamma

Adjusts the midtone density of the scanned image.

Threshold

Adjusts the level at which black areas in text and line art are delineated, improving text recognition in OCR (Optical Character Recognition) programs.

Edge Fill

Corrects shadowing around the edges of the image by filling the shadows with black or white.

Remove Punch Holes

Removes the shadows caused by holes on the edges of the original.

Dual Image Output

Scans the original image twice using different output settings (Windows only).

Watermark

Adds text to the background of the scanned image.

Parent topic: [Scanning in Epson Scan 2](#)

Scanning Settings for Special Documents

You need to select specific options on the Main Settings tab in Epson Scan 2 when scanning special originals.

Type of original	Required settings
Envelope	Select Off as the Detect Double Feed setting.
Plastic cards	Select Plastic Card (Landscape) as the Document Size setting and Off as the Detect Double Feed setting.
Carrier sheet	If you select Auto Detect as the Document Size setting, paper skew is automatically corrected even if the Correct Document Skew setting is set to Off . If you select a setting other than Auto Detect as the Document Size setting, you can only use Contents Skew as the Correct Document Skew setting. As paper skew is not applied in this case, only contents skew is corrected when you select the Paper and Contents Skew setting.
Large originals	If the Document Size list does not contain the document size you want to scan, select Customize to create a custom size.

Type of original	Required settings
Long paper	If the Document Size list does not contain the document size you want to scan, select Auto Detect (Long Paper) or select Customize to create a custom document size.
Laminated cards	To scan any transparent areas around the edges of the card, select Settings as the Document Size setting and either select the Scan laminated card checkbox or create a custom size.

Parent topic: [Scanning in Epson Scan 2](#)

Image Format Options

You can select different image formats and related options. For details on available options, click the ? icon on the Epson Scan 2 Image Format Options window. Not all image formats have options.

BITMAP (*.bmp)

A standard image file format for most Windows programs.

JPEG (*.jpg)

An image format that lets you highly compress image data. However, the higher the compression, the lower the image quality. (The TIFF format is recommended when you need to modify or retouch your scanned image.)

PNG (*.png)

An image format that does not lose quality during editing.

TIFF (*.tif)

A file format created for exchanging data between many programs, such as graphic and DTP software.

Multi-TIFF (*.tif)

A TIFF file format when multiple pages are saved to the same file, allowing you to edit the images using a compatible program.

PDF (*.pdf)

A document format that is readable by Windows and Mac systems using Adobe Reader, Acrobat, or other programs. You can save multi-page documents in one PDF file.

Searchable PDF (*.pdf)

A document format that is readable by Windows and Mac systems using Adobe Reader, Acrobat, or other programs. You can save multi-page documents in one PDF file. Recognized text in the scanned document can be searched.

Note: If you do not see the Searchable PDF option, run the Epson Software Updater and install the EPSON Scan OCR Component/Pro.

Parent topic: [Scanning in Epson Scan 2](#)

Scan Resolution Guidelines

The resolution setting in your scanning software, measured in dpi (dots per inch), controls the amount of detail captured in your scans. Increasing the resolution raises the amount of detail captured but comes with the following disadvantages:

- Larger file sizes
- It takes longer to scan your originals, send/receive your scans by email or fax, and to print your scans
- The image may become too large to fit on your display or print on paper
- The maximum length you can scan is reduced

If you plan to enlarge a scanned image so you can print it at a larger size, you may need to increase the resolution from the default resolution set by the software. Follow these guidelines to determine the resolution setting you need:

- You will scan the image at its original size but enlarge it later in an image-editing program.

Increase the resolution setting in your scanning software. Increase the resolution by the same amount you will increase the image size to retain a high image quality. For example, if the resolution is 300 dpi (dots per inch) and you will double the image size later, change the resolution setting to 600 dpi.

- You will scan the image at 100% or smaller size.

Select the resolution setting based on how you will use the scanned image:

- Email/view on a computer screen/post on the web: 96 to 200 dpi
- Print/fax/convert to editable text (OCR)/create searchable PDF: 200 to 300 dpi

Parent topic: [Scanning](#)

Scanning Special Projects

Your product's scanning software offers various options to help you quickly complete special scan projects.

[Scanning Two Originals onto One Sheet \(Stitching Images\) - Windows](#)

[Scanning Multi-Page Originals as Separate Files - Windows](#)

[Saving Scanned Documents as a Searchable PDF Using Epson Scan 2](#)

[Saving a Scan as an Office Format File - Windows](#)

[Scanning to a SharePoint Server or Cloud Service - Windows](#)

[Scanning to a SharePoint Server or Cloud Service - Mac](#)

Parent topic: [Scanning](#)



Scanning Two Originals onto One Sheet (Stitching Images) - Windows

You can scan both sides of a double-sided or folded original in Document Capture Pro and combine them into a single image with the Epson Scan 2 Stitch Images setting (not available for all products).

Note: Settings may vary depending on the software version you are using. Click the **Help** icon in Document Capture Pro at any time for more information.

1. Load your original in the product.

Note: If an optional carrier sheet is included with your product, use it when scanning a folded original or damage to the original may occur. Place the original into the carrier sheet with the folded edge against the right side of the carrier sheet. Make sure to insert the carrier sheet into your product with the white edge facing down.

2. Do one of the following to start Document Capture Pro:
 - **Windows 10:** Click  and select **Epson Software > Document Capture Pro**.
 - **Windows 8.x:** Navigate to the **Apps** screen and select **Document Capture Pro**.
 - **Windows (other versions):** Click  or **Start** and select **All Programs** or **Programs**. Select **Epson Software > Document Capture Pro**.
3. Select the **Simple Scan** tab.

You see a window like this:

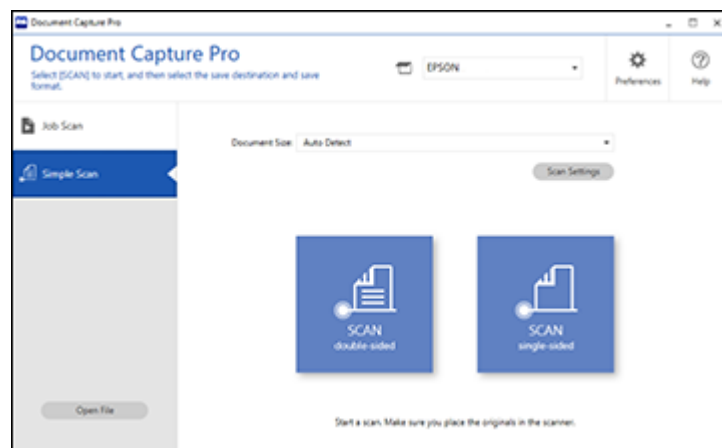

4. Click **Scan Settings** > **Detailed Settings**.

You see an Epson Scan 2 window like this:

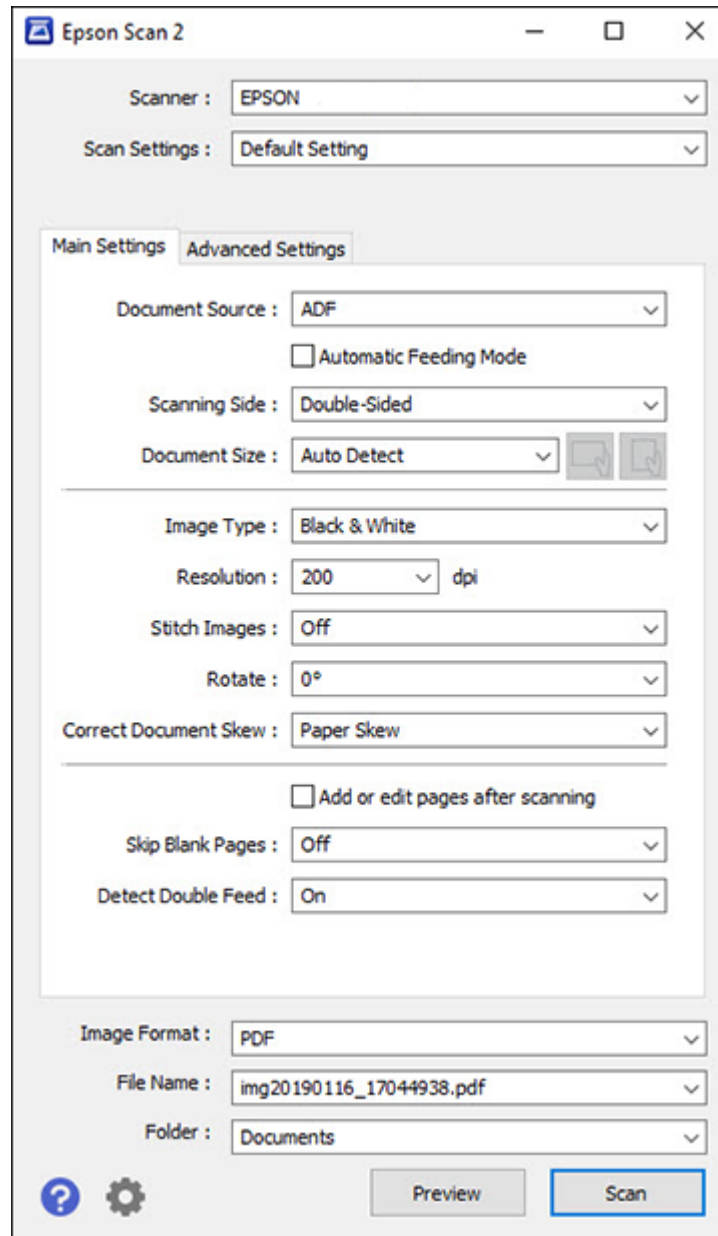

5. Select **Double-Sided** as the **Scanning Side** setting.
6. Select the original document size or **Auto Detect** as the **Document Size** setting.
7. Select one of the following as the **Stitch Images** setting:
 - **Top & Bottom**: Places the scanned images one above the other.
 - **Left & Right**: Places the scanned images side by side.
8. Select the **Advanced Settings** tab and verify that the **Edge Fill** setting is set to **None**.
9. Click **Save**.
10. Click **OK**.
11. Click **SCAN double-sided**.

Your product scans the original and the image appears in the Edit Scanned Results window.

Note: If the scanned images are not stitched together in the correct orientation, click **Scanning Side** on the Epson Scan 2 window, select **Settings**, set the Binding Edge to **Left** or **Top**, and rescan the document.

12. Review and edit the scanned pages as necessary and click **Next** when you are finished.
13. Select a destination and any settings as necessary and click **Complete**.

Parent topic: [Scanning Special Projects](#)

Scanning Multi-Page Originals as Separate Files - Windows

You can use Document Capture Pro to scan multi-page originals as separate scanned files. You can indicate how the separate files are created by defining a maximum page count per file or by inserting blank pages, barcodes, or characters that can be detected by the software as separation markers.

Note: Settings may vary depending on the software version you are using. Click the **Help** icon in Document Capture Pro at any time for more information.

1. Load your multi-page original in the product.
2. Do one of the following to start Document Capture Pro:
 - **Windows 10:** Click  and select **Epson Software > Document Capture Pro**.
 - **Windows 8.x:** Navigate to the **Apps** screen and select **Document Capture Pro**.

- **Windows (other versions):** Click  or **Start**, and select **All Programs** or **Programs**. Select **Epson Software > Document Capture Pro**.

You see the Document Capture Pro window.

3. Select the **Job Scan** tab.

You see a window like this:

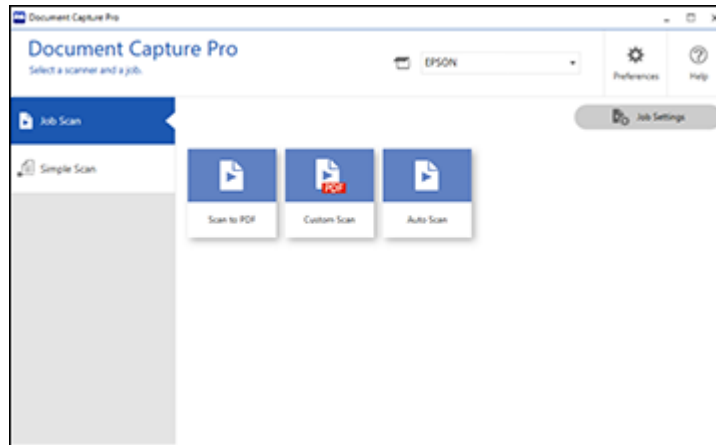

4. Click the **Job Settings** button.

You see a window like this:

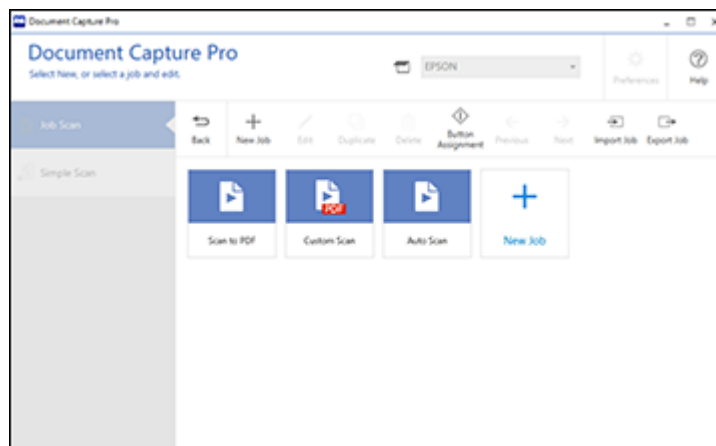

5. Select **New Job** and select the scan settings. Click **Next** when finished.
You see a window like this:

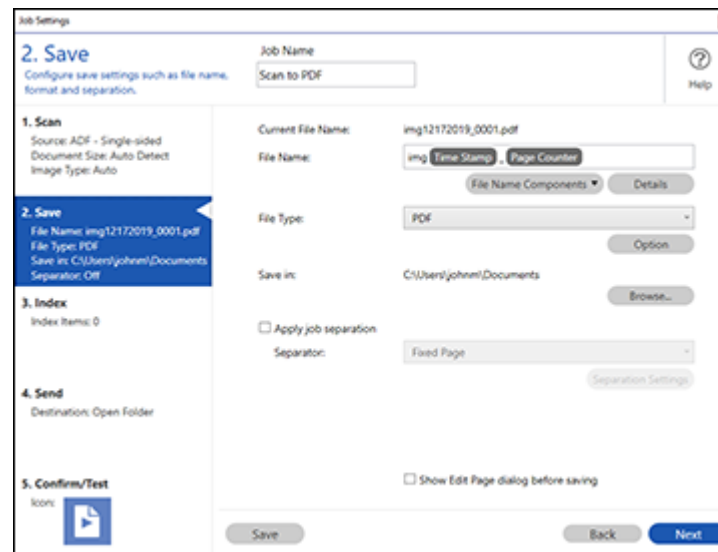

6. Select the **Apply job separation** checkbox.
7. Select the method you want to use to separate the originals as the **Separator** setting. Click **Separation Settings** to specify the settings for the selected option.
8. Finish creating the new scan job and click **Save**.
9. Click **Back** on the Job Settings screen.

Your originals are saved into separate files and folders as specified when the job is run.

Parent topic: [Scanning Special Projects](#)

Saving Scanned Documents as a Searchable PDF Using Epson Scan 2

You can scan a document and save the text in a searchable PDF. In a searchable PDF, text is recognized using Optical Character Recognition (OCR) and then embedded in the scanned original.

Note: The required Epson Scan 2 OCR Component is installed automatically when you install your product software. If you install your scanner software programs individually, be sure to also install this component if you want to perform OCR.

1. Load your original in the product for scanning.
2. Start Epson Scan 2.
3. Select your scan settings.
4. Click **Preview** and adjust the area you want to scan, if necessary.
5. Reload the ejected original in the scanner.
6. Select **Searchable PDF** as the Image Format setting.
7. Select **Options** from the Image Format list.

You see this window:

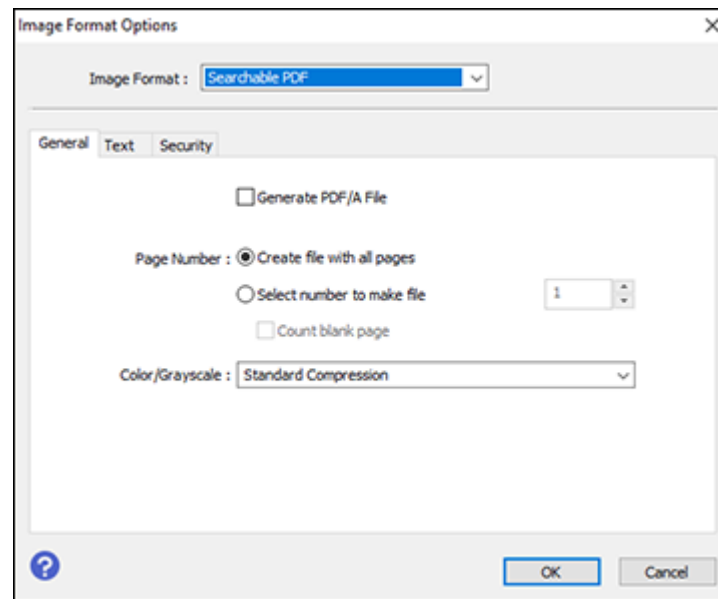

8. Select any of the options on the **General** tab.
9. Select the **Text** tab.
10. Make sure the language used in the document text is selected as the **Text Language** setting.
11. Select the **Security** tab if you want to add a password to the PDF or protect printing or editing properties.
12. Click **OK**.

13. Confirm the **File Name** setting and select a **Folder** setting for your document.
14. Click **Scan**.



The scanned image is saved as a searchable PDF.

Parent topic: [Scanning Special Projects](#)

Saving a Scan as an Office Format File - Windows

You can use Document Capture Pro (Windows) to save your scans in one of the following Microsoft Office file formats: Microsoft Word (.docx), Microsoft Excel (.xlsx), or Microsoft PowerPoint (.pptx).

Note: The settings may vary, depending on the software version you are using. See the help information in Document Capture Pro for details.

1. Load your original in the product.
2. Do one of the following to start Document Capture Pro:
 - **Windows 10:** Click  and select **Epson Software > Document Capture Pro**.
 - **Windows 8.x:** Navigate to the **Apps** screen and select **Document Capture Pro**.
 - **Windows (other versions):** Click  or **Start**, and select **All Programs** or **Programs**. Select **Epson Software > Document Capture Pro**.
3. Select the **Simple Scan** tab.

You see a window like this:

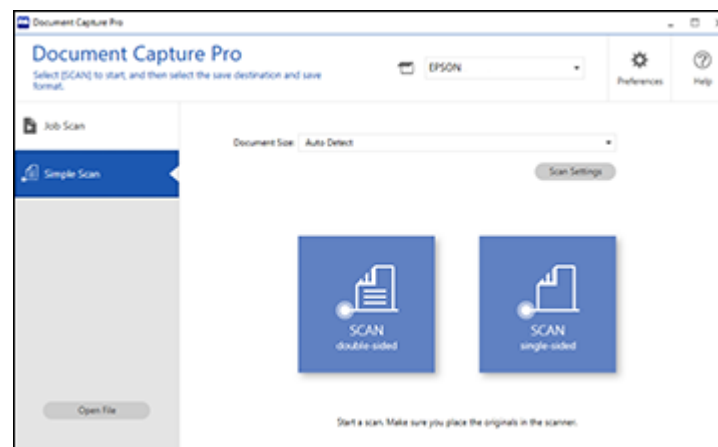

4. If you want to select specific scan settings for the scan, click the **Scan Settings** button, select any displayed settings you want to use, and click **OK**.

Note: See the help information in Document Capture Pro for details.

5. Do one of the following:
 - To scan the front side of an original, select **SCAN single sided**.
 - To scan both sides of an original, select **SCAN double sided**.Your product starts scanning and you see the Edit Scanned Results window.
6. View and edit the scanned pages as necessary and click **Next** when you are finished.

Note: See the help information in Document Capture Pro for details.

7. Click one of the destination icons (except **Print**) to choose where to send your scanned files. You see the settings window.
8. Select the Office format file you want to use from the **File Type** drop-down list.
9. Click **Option** to display additional settings.
10. Select any additional settings as necessary and click **OK**.

Note: See the help information in Document Capture Pro for details.

11. Confirm your settings and click **Complete**.
Your originals are saved in the Office file format you selected.



Parent topic: [Scanning Special Projects](#)

Scanning to a SharePoint Server or Cloud Service - Windows

You can use Document Capture Pro to upload scanned images to a SharePoint server or a cloud service.

Note: The settings may vary, depending on the software version you are using. See the help information in Document Capture Pro for details.

1. Load your original in the product.

2. Do one of the following to start Document Capture Pro:
 - **Windows 10:** Click  and select **Epson Software > Document Capture Pro**.
 - **Windows 8.x:** Navigate to the **Apps** screen and select **Document Capture Pro**.
 - **Windows (other versions):** Click  or **Start**, and select **All Programs** or **Programs**. Select **Epson Software > Document Capture Pro**.
3. Select the **Simple Scan** tab.

You see a window like this:

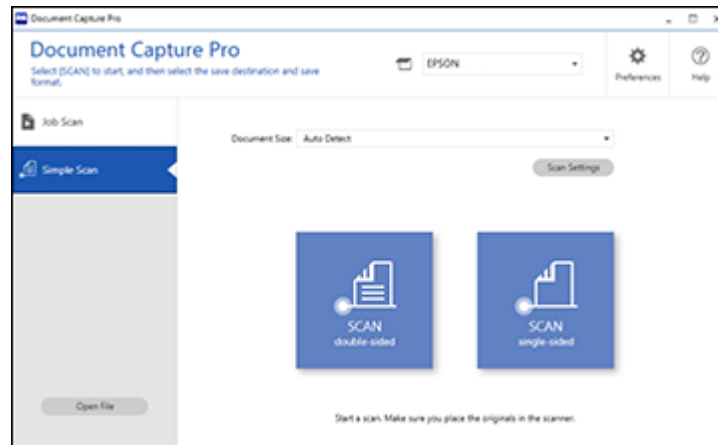

4. If you want to select specific scan settings for the scan, click the **Scan Settings** button, select any displayed settings you want to use, and click **OK**.

Note: See the help information in Document Capture Pro for details.

5. Do one of the following:
 - To scan the front side of an original, select **SCAN single sided**.
 - To scan both sides of an original, select **SCAN double sided**.

Your product starts scanning and you see the Edit Scanned Results window.

6. View and edit the scanned pages as necessary and click **Complete** when you are finished.

Note: See the help information in Document Capture Pro for details.

7. Click one of the cloud server or service destination icons. You see the settings window.
8. Enter any required information to set up the destination. You may need to log in to your cloud service to authenticate the connection and allow Document Capture Pro to access the cloud service.
9. Adjust any settings and click **Complete**.

Note: See the help information in Document Capture Pro for details.

Your originals are uploaded to the indicated server or cloud service.

Parent topic: [Scanning Special Projects](#)

Scanning to a SharePoint Server or Cloud Service - Mac

You can use Document Capture to upload scanned images to a SharePoint server or a cloud service.

1. Open the **Applications** folder, open the **Epson Software** folder, and select **Document Capture**.

You see a window like this:

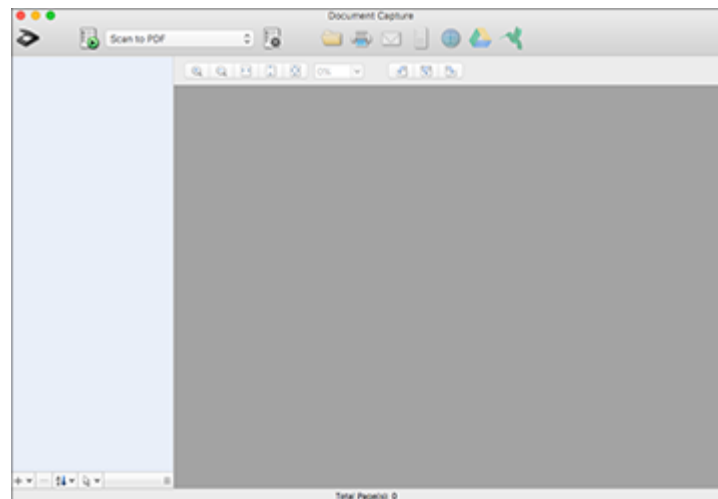

Note: You may need to select your scanner from the scanner list.

2. Click the  scan icon.
3. Select any displayed scan settings you want to use.

Note: See the Help information in Document Capture for details.

4. Click **Scan**.
You see a preview of your scan in the Document Capture window.
5. Click one of the cloud service Destination icons to choose where to save your scanned file. (If you cannot see all of the icons, the service software may not be installed, the service may not be available on your platform, or you need to click the arrow next to the icons.)
You see the Transfer Settings window.
6. Enter any required information to set up the destination. You may need to log in to your cloud service to authenticate the connection and allow Document Capture to access the cloud service. If you have previously created a saved setting for the destination, select it from the drop-down list.
7. Adjust any save settings, then click **OK** or **Send**, depending on the destination.
Your originals are scanned and uploaded to the indicated server or cloud service.

Parent topic: [Scanning Special Projects](#)

Related tasks

[Loading Originals in the Input Tray](#)

Cleaning and Transporting Your Scanner

See these sections if you need to clean or transport your scanner.

[Cleaning Your Scanner](#)

[Cleaning Inside Your Scanner](#)

[Checking the Scanner Roller Counter](#)

[Replacing the Scanner Rollers](#)

[Transporting Your Scanner](#)

Cleaning Your Scanner

To keep your product working at its best, you should clean it several times a year.

Caution: Do not use a hard brush, alcohol, or paint thinner to clean the product or you may damage it. Do not use oil or other lubricants inside the product or let water get inside it. Do not open the product's outer case.

1. Turn off the scanner and unplug the AC adapter.
2. Disconnect any connected cables.
3. Clean the outer case with a soft, dry cloth. Do not use liquid or chemical cleansers.

Note: If the outer case still requires additional cleaning, use a slightly damp cloth to wipe the outer case. Then wipe the case with a soft, dry cloth.

4. Clean the LCD screen with a soft, dry cloth.

Parent topic: [Cleaning and Transporting Your Scanner](#)

Cleaning Inside Your Scanner

Clean your scanner regularly to make sure that no dust builds up on the glass scanning surfaces. Dust can cause spots or lines in your scanned images.

Caution: Do not use a hard brush, alcohol, or paint thinner to clean the product or you may damage it. Do not use oil or other lubricants inside the product or let water get inside it.

1. Turn off the scanner and unplug the AC adapter.

2. Disconnect any connected cables.
3. Pull down on the cover open lever and open the scanner cover.

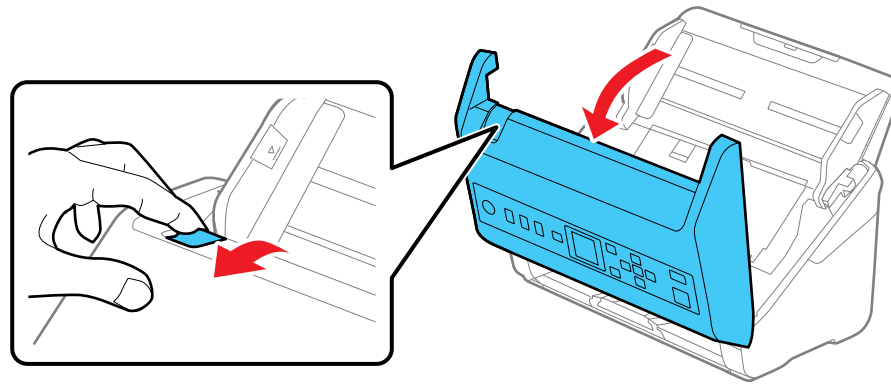

4. Use a genuine Epson cleaning kit or a soft, moist cloth to wipe off any dust or dirt on the glass scanning surfaces and the rollers inside the scanner cover. If the glass surface is stained with grease or some other hard-to-remove material, use a genuine Epson cleaning kit. Use a small amount of cleaner on the cleaning cloth to remove the stains. Be sure to wipe off all remaining liquid.

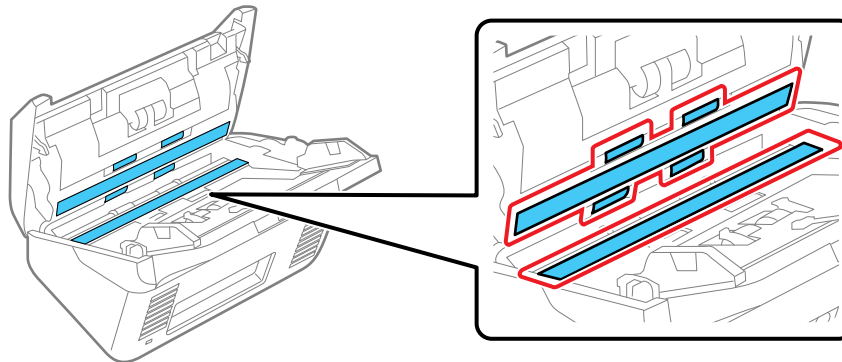

Caution: Do not spray glass cleaner directly on the scanning surfaces. Be careful not to place too much force on the glass.

5. Use a cotton swab to wipe off any dust or dirt on the sensors shown here.

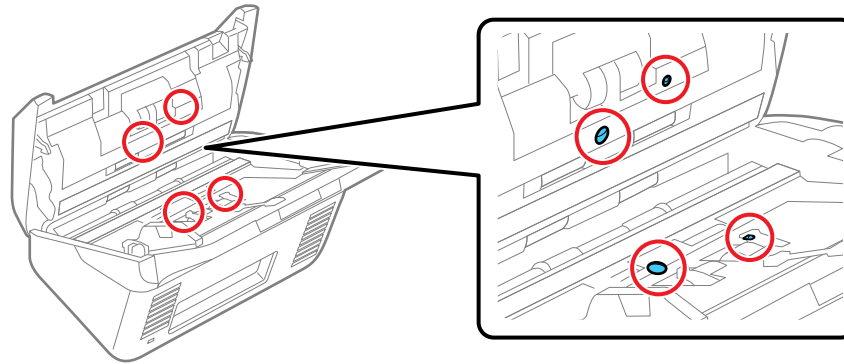

Caution: Do not use liquid or glass cleaner on the cotton swab.

6. Locate the separation roller.

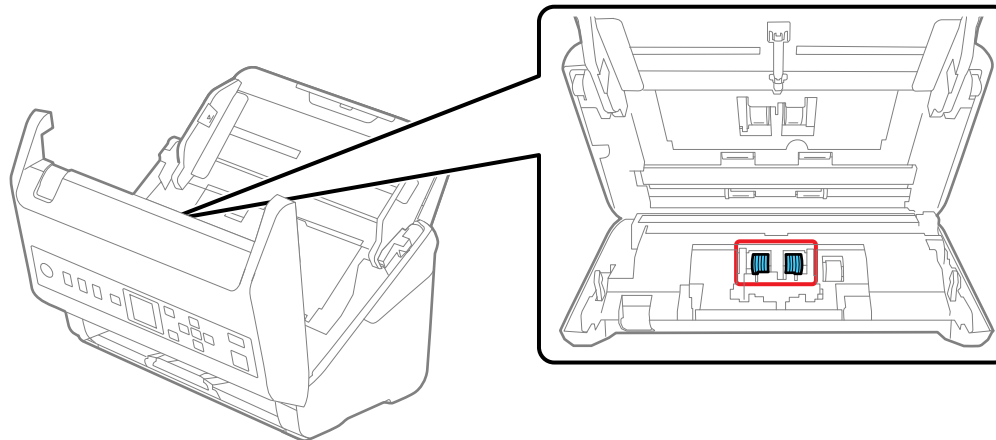

7. Squeeze the tabs on the sides of the separation roller cover and open the cover.

Caution: Be careful not to apply too much force when opening the cover.

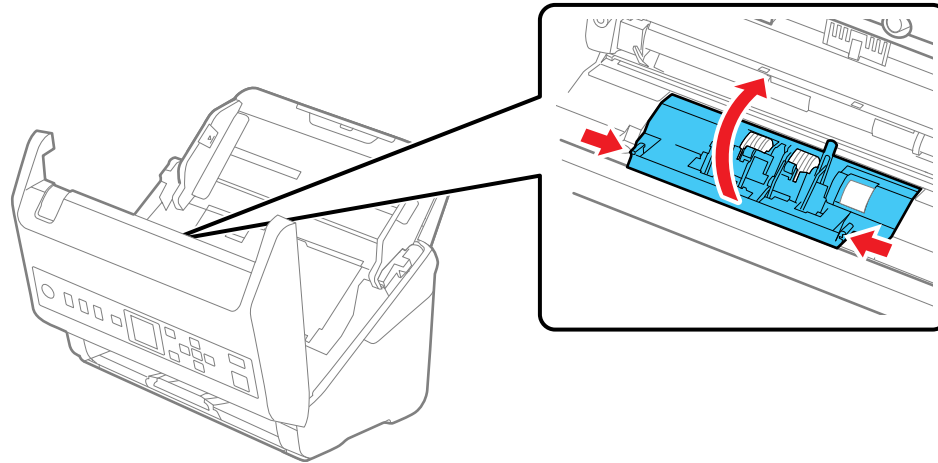

8. Slide the separation roller to the left and remove it.

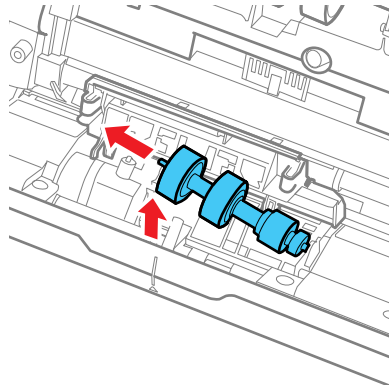

9. Wipe off any dust or dirt on the separation roller using a genuine Epson cleaning kit or a soft, moist cloth.

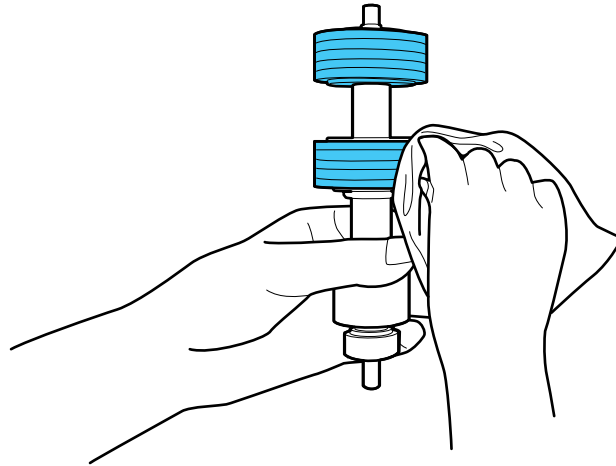

Caution: Use only a genuine Epson cleaning kit or soft, moist cloth to clean the roller; using a dry cloth may damage the surface of the roller. Do not spray cleaners directly inside the product; always spray cleaners on a cleaning cloth to slightly dampen the cloth. Wipe off any excess cleaner with a dry, lint-free cloth.

10. To replace the separation roller, insert the end of the roller into the hole on the right side and lower the other end of the roller into place.

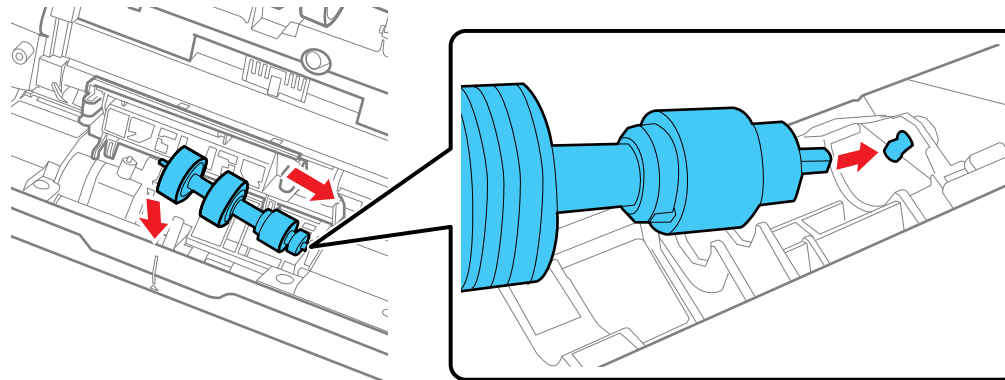

11. Close the separation roller cover until you hear it click into place.

Note: If you are not able to close the cover, the roller is not installed correctly. Remove the roller and reinstall it, then try to close the cover again.

12. Locate the pickup roller.

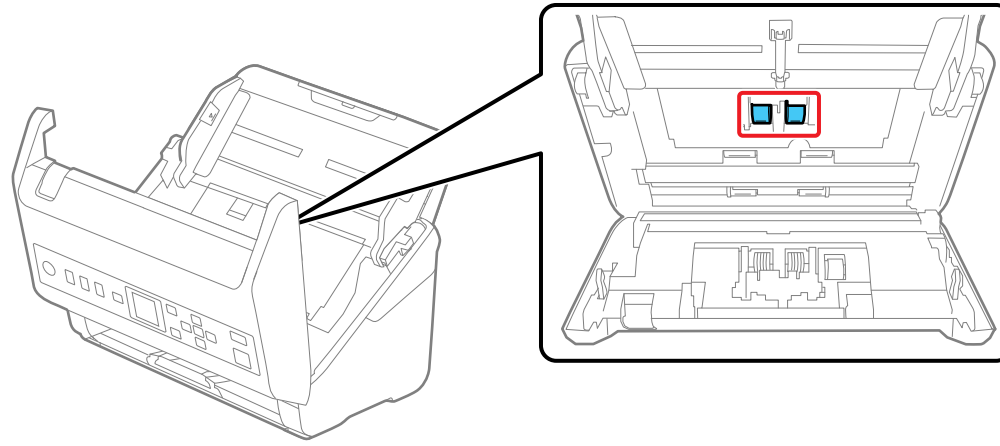

13. Press down on the pickup roller cover latch and pull up the cover to remove it.

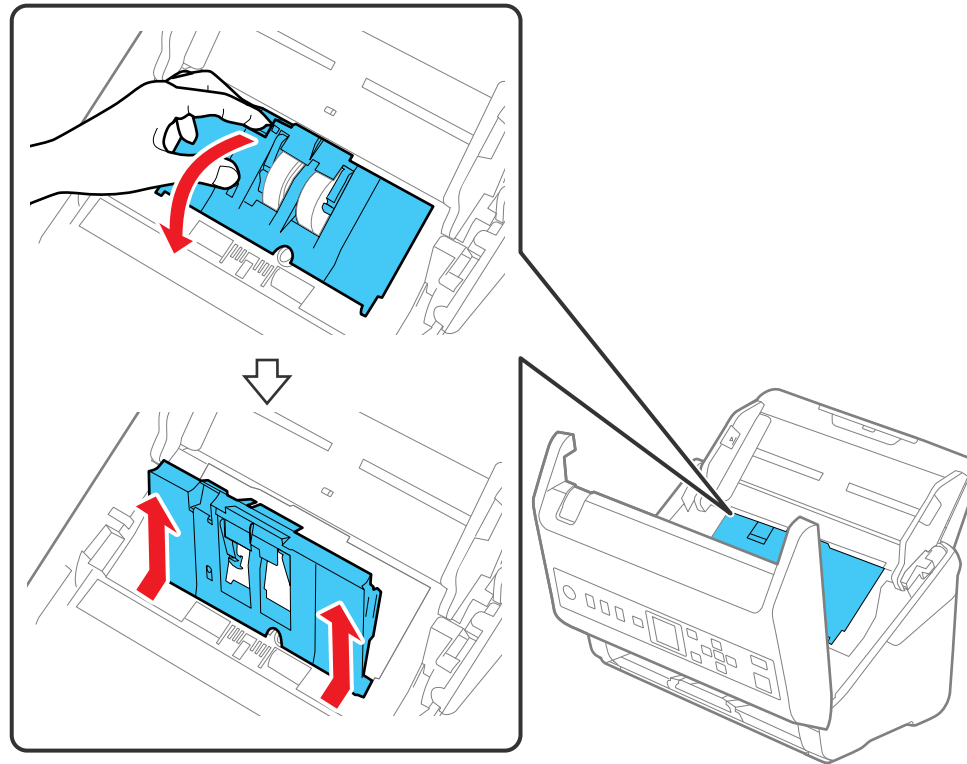

14. Pull down the tab on the pickup roller and slide the roller to the right to remove it.

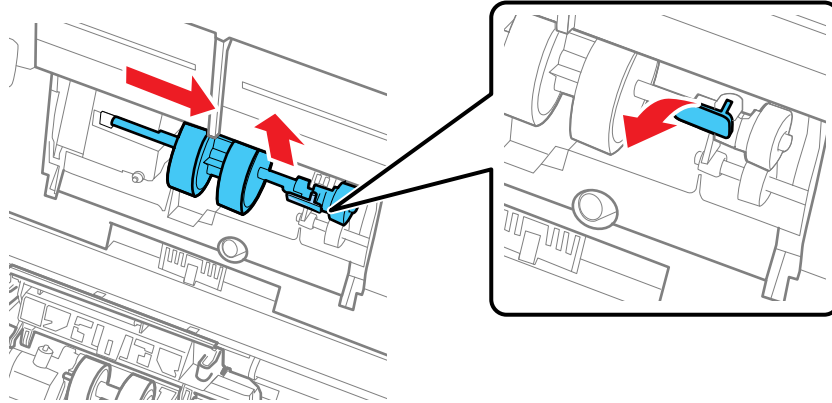

15. Wipe off any dust or dirt on the pickup roller using a genuine Epson cleaning kit or a soft, moist cloth.

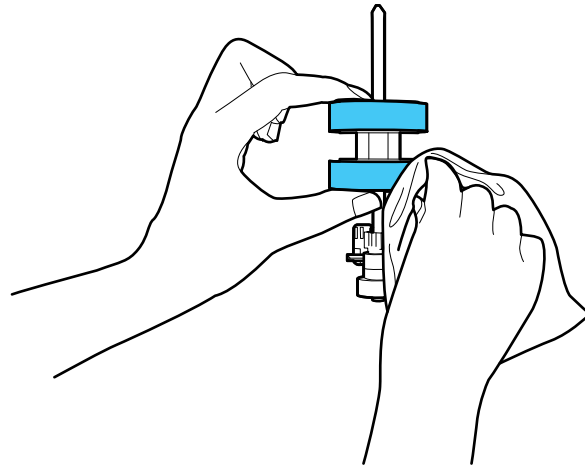

Caution: Use only a genuine Epson cleaning kit or soft, moist cloth to clean the roller; using a dry cloth may damage the surface of the roller.

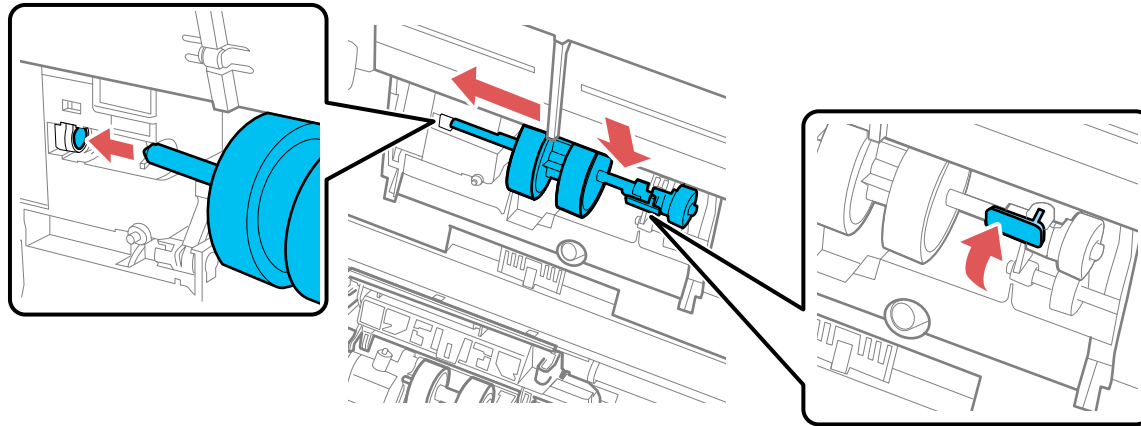

16. To replace the pickup roller, align the notches on the roller unit and slide it to the left. Press up on the tab to secure the roller.

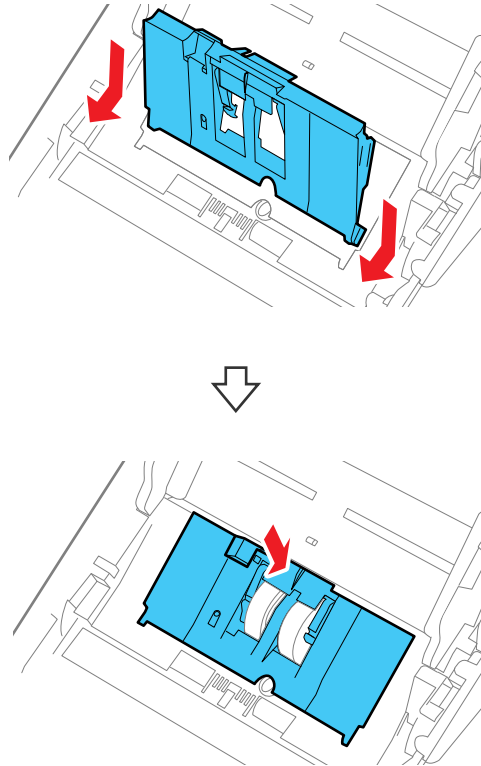

17. Align the bottom edge of the pickup roller cover into the notches as shown and press it down until it clicks into place.



Note: If you are not able to close the cover, the roller is not installed correctly. Remove the roller unit and reinstall it, then try to close the cover again.

18. Close the scanner cover.
19. Plug in the AC adapter and press the  power button to turn on the scanner.
20. Press the  home button, if necessary.
21. Use the arrow buttons to select **Scanner Maintenance** and press **OK**.
22. Press **OK** to select **Roller Cleaning**.

23. Pull down on the cover open lever and open the scanner cover.

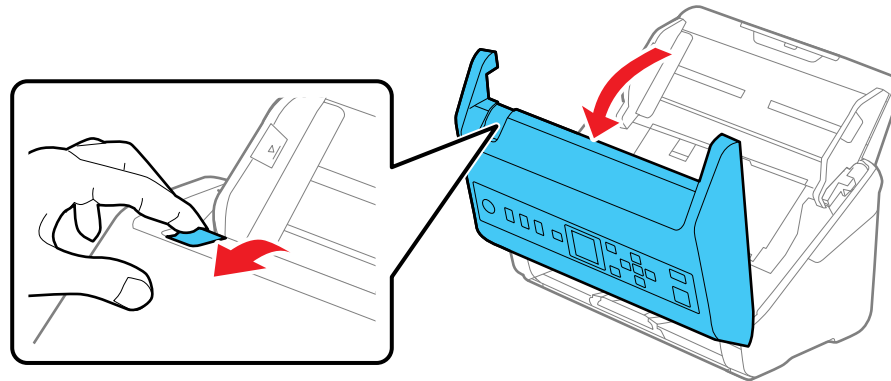

The scanner enters roller cleaning mode.

24. Slowly rotate the rollers shown here by pressing the  start button. Use a genuine Epson cleaning kit or a soft, moist cloth to wipe off any dust or dirt on the rollers as they rotate. Repeat this step until the rollers are clean.

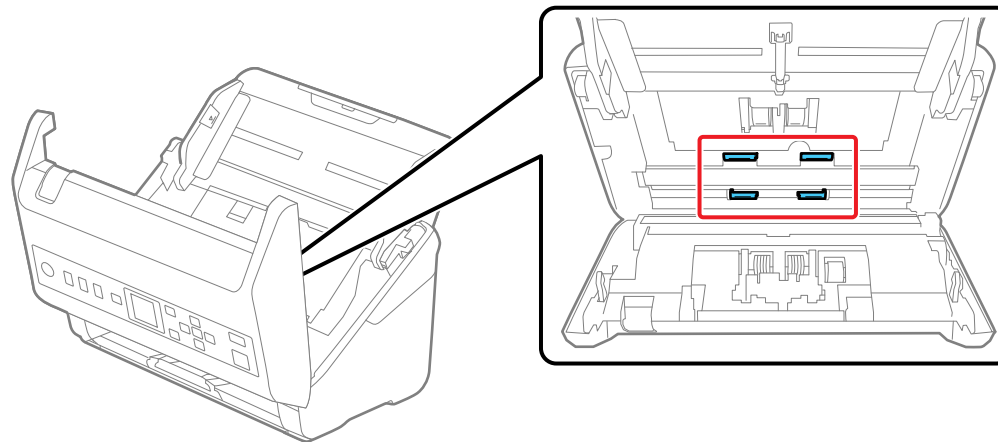

Caution: Be careful not to get your hands or hair caught in the rollers as they rotate.



Note: Do not spray cleaners directly inside the product; always spray cleaners on a cleaning cloth to slightly dampen the cloth. Wipe off any excess cleaner with a dry, lint-free cloth.

25. Close the scanner cover.

Parent topic: [Cleaning and Transporting Your Scanner](#)

Checking the Scanner Roller Counter

Check the scanner roller counter to determine when your rollers need to be replaced. When you replace the scanner rollers, reset the scanner roller counter so you know when you may need to replace the rollers again.

1. Make sure the scanner is turned on and connected to your computer.
2. Do one of the following to open the Epson Scan 2 Utility:
 - **Windows 10:** Click  and select **EPSON > Epson Scan 2 Utility**.
 - **Windows 8.x:** Navigate to the **Apps** screen and select **Epson Scan 2 Utility**.
 - **Windows (other versions):** Click  or **Start > All Programs** or **Programs > EPSON > Epson Scan 2 > Epson Scan 2 Utility**.
 - **Mac:** Open the **Applications** folder, click **Epson Software**, and click **Epson Scan 2 Utility**.
3. Click the **Counter** tab.

You see a screen like this:

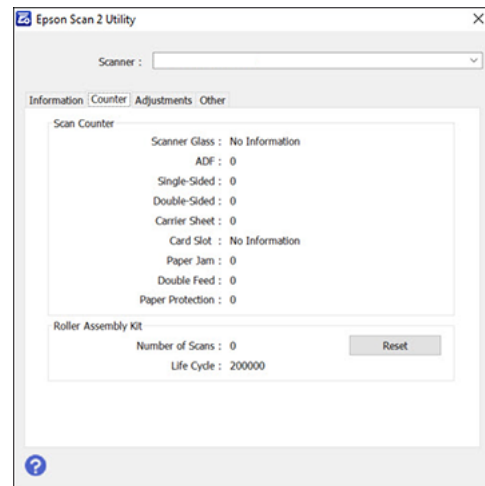

4. If the number in the **Number of Scans** field exceeds the number displayed as the **Life Cycle** of the rollers, it is time to replace the rollers.
5. Close the Epson Scan 2 Utility.

Parent topic: [Cleaning and Transporting Your Scanner](#)

Replacing the Scanner Rollers

Replace the scanner rollers when the number of scans exceeds the life cycle of the rollers. Check the scanner roller counter to see when you need to replace the rollers.

Note: Frequent use of textured media may cause premature wear on the rollers. If frequent paper jams occur before the life cycle of the rollers is exceeded, try cleaning the rollers. In some cases, the rollers may need to be replaced before the number of scans exceeds the life cycle of the rollers.

1. Turn off the scanner.
2. Unplug the AC adapter.
3. Disconnect any connected cables.
4. Pull down on the cover open lever and open the scanner cover.

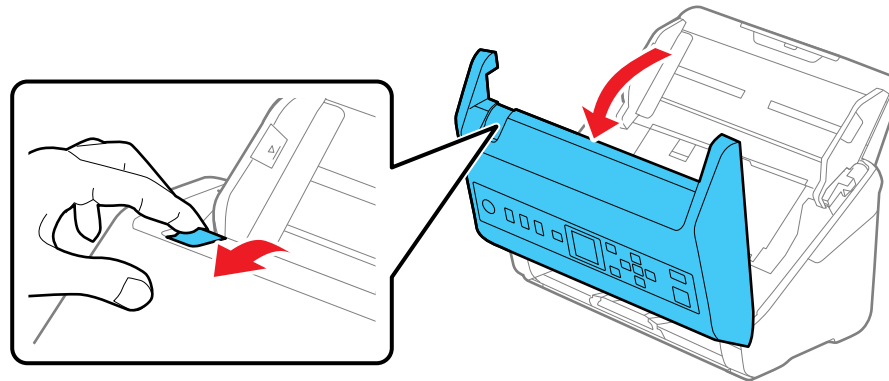

5. Press down on the pickup roller cover latch and pull up the cover to remove it.

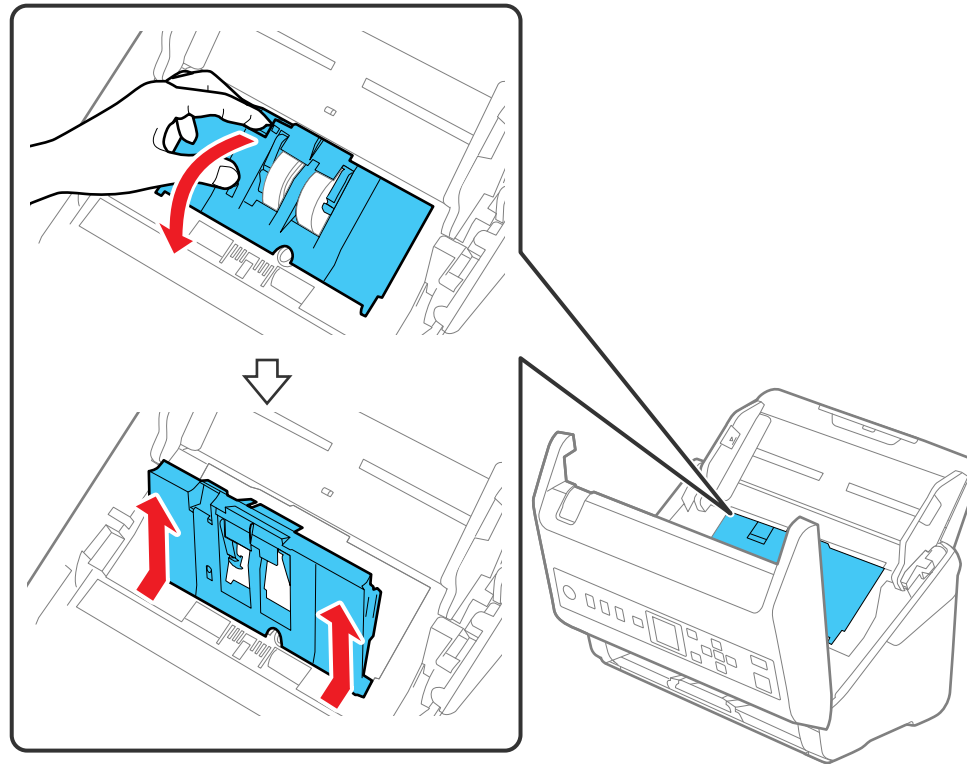

6. Pull down the tab on the pickup roller and slide the roller to the right to remove it.

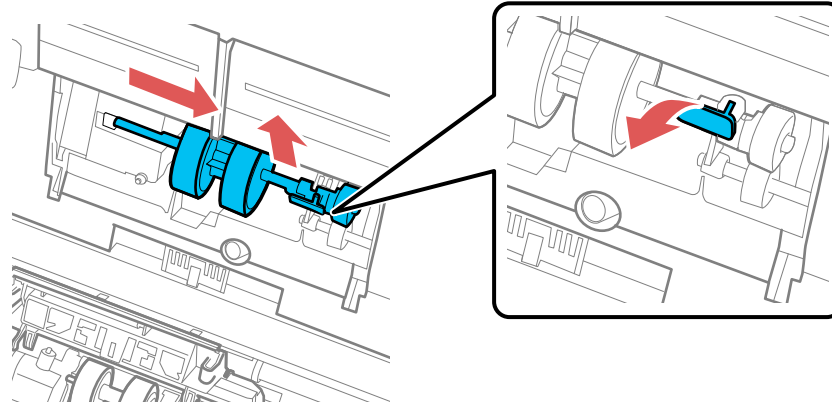

7. To install the new pickup roller, align the notches on the roller unit and slide it to the left. Press up on the tab to secure the roller.

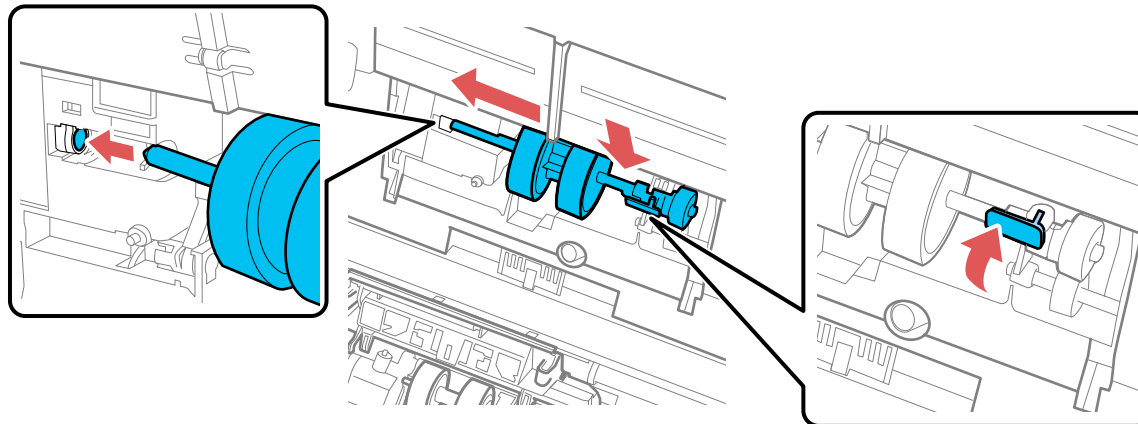

8. Align the bottom edge of the pickup roller cover into the notches as shown and press it down until it clicks into place.

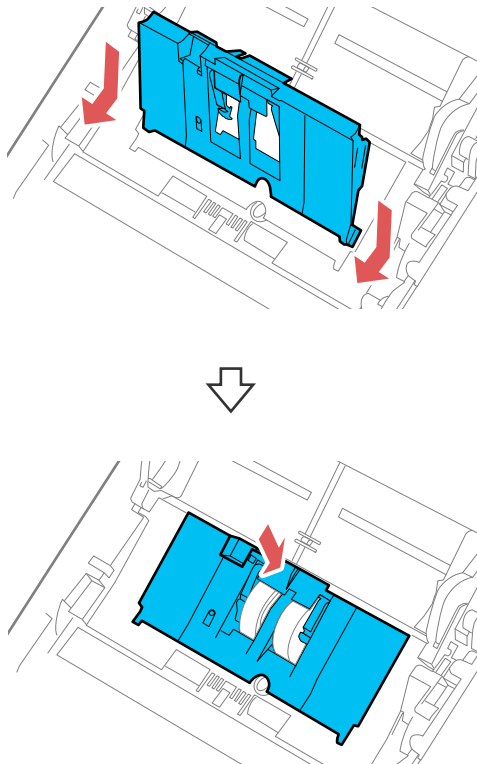

Note: If you are not able to close the cover, the pickup roller is not installed correctly. Remove the roller unit and reinstall it, then try to close the cover again.

9. Squeeze the tabs on the sides of the separation roller cover and open the cover.

Caution: Be careful not to apply too much force when opening the cover.

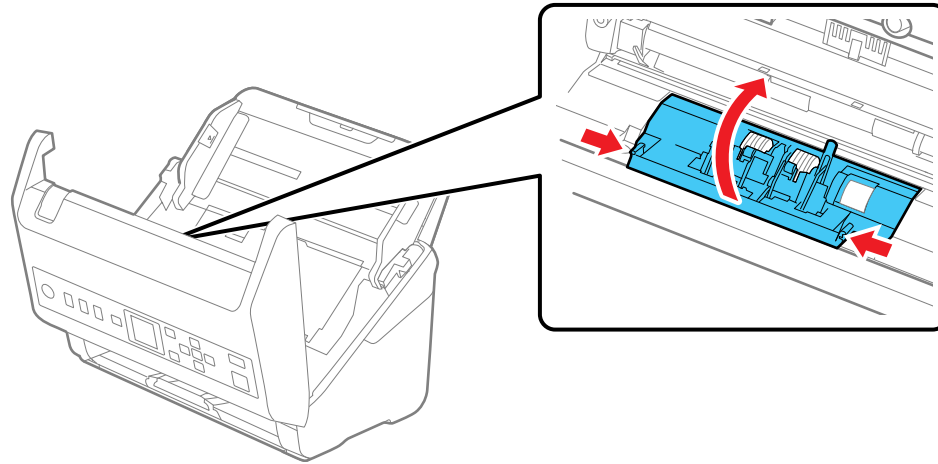

10. Slide the separation roller to the left and remove it.

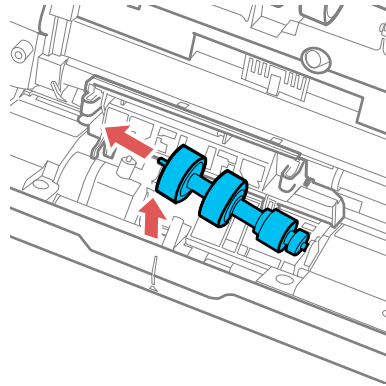

11. To install a new separation roller, insert the end of the roller into the hole on the right side and lower the other end of the roller into place.

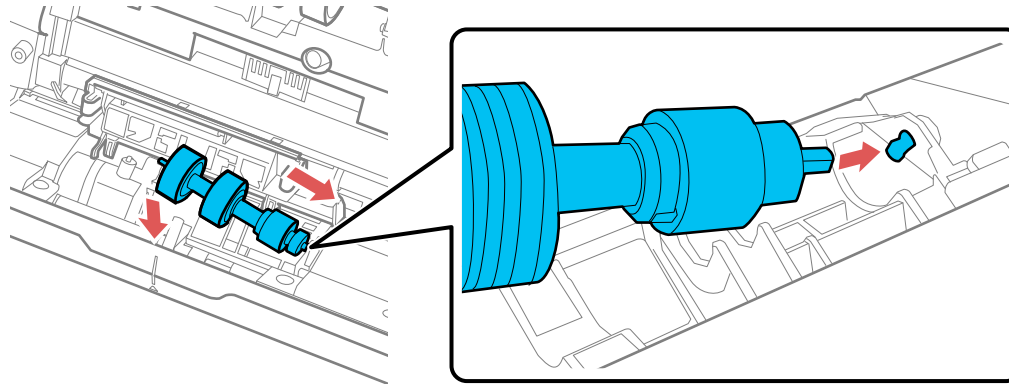

12. Close the separation roller cover until you hear it click into place.

Note: If you are not able to close the cover, the roller is not installed correctly. Remove the roller and reinstall it, then try to close the cover again.

13. Close the scanner cover.
14. Connect any disconnected cables.
15. Plug in the AC adapter and turn on the scanner.
16. Reset the roller counter.

[Resetting the Scanner Roller Counter](#)

Parent topic: [Cleaning and Transporting Your Scanner](#)

Resetting the Scanner Roller Counter

When you replace the scanner rollers, reset the scanner roller counter so you know when you may need to replace the rollers again.

1. Press the **OK** button, if necessary.
2. Use the arrow buttons to select **Scanner Maintenance** and press **OK**.
3. Use the arrow buttons to select **Roller Replacement** and press **OK**.

4. Follow the on-screen instructions to replace the rollers.
5. Press the down arrow to select **Reset Counter** and press **OK**.

Note: You can also reset the roller counter from your computer using the Epson Scan 2 Utility. Select the **Counter** tab and click **Reset**.

Parent topic: [Replacing the Scanner Rollers](#)

Transporting Your Scanner

If you need to ship your product, transport it a long distance, or store it for an extended period, prepare it for transportation as described here.

1. Turn off the scanner and unplug the AC adapter.
2. Disconnect any connected cables.
3. Close the input tray extension and the output tray.

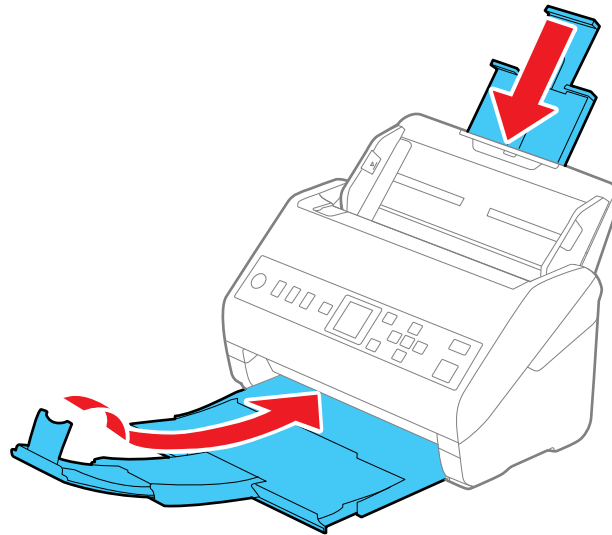

Note: Make sure the output tray is securely closed.

4. Push apart the latches on the back on the input tray and lift the input tray off of the scanner.

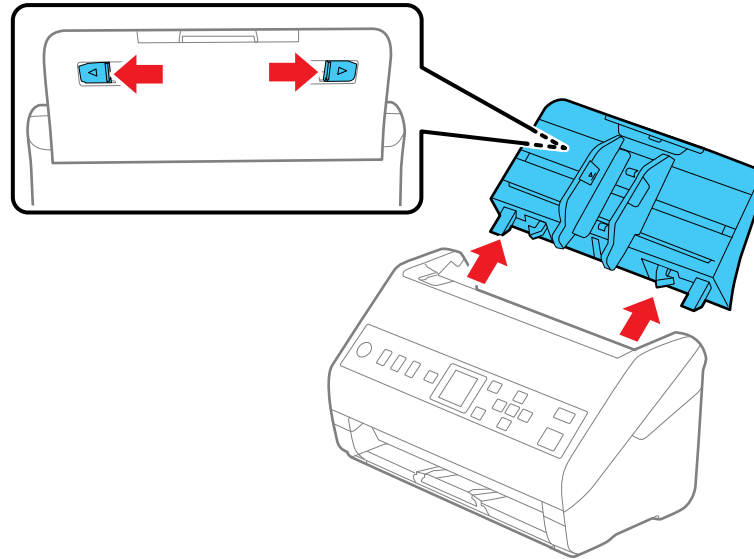

5. Place the scanner in its original packing materials, if possible, or use equivalent materials with cushioning around the product.

Parent topic: [Cleaning and Transporting Your Scanner](#)

Solving Problems

Check these sections for solutions to problems you may have using your product.

[Product Status Messages](#)

[Solving Scanning Problems](#)

[Solving Scanned Image Quality Problems](#)

[Resetting the Epson Scan 2 Settings](#)

[Uninstall Your Scanner Software](#)

[Where to Get Help \(U.S. and Canada\)](#)

[Where to Get Help \(Latin America\)](#)

Product Status Messages

You can often diagnose problems with your product by checking the messages and status icons on its LCD screen.

Note: If the LCD screen is dark, press the screen to wake the product from sleep mode.

LCD screen message	Condition/solution
Computer not found. For details, see your documentation.	Try the following: <ul style="list-style-type: none">• Make sure the scanner is connected and correctly configured.• Install Epson Scan 2 and Document Capture Pro (Windows), or Document Capture (Mac) on your computer.• Install the latest version of the application.• Make sure the AC adapter is securely connected to the scanner and an electrical outlet. Check that the outlet is working properly by plugging another electrical device into it.• Check the firewall settings for Epson software.• Make sure the Group setting is the same for the computer and the scanner.• Search for the computer again.
Scanner error. For details, see your documentation.	Turn the power off and on again. If the error continues, contact Epson.

LCD screen message	Condition/solution
Recovery mode	An error has occurred during firmware updating. Connect your product using a USB cable and try downloading the Firmware Update from the Epson support site. If you still need help, contact Epson for support.

Parent topic: [Solving Problems](#)

Solving Scanning Problems

Check these solutions if you have problems scanning with your product.

[Scanner Does Not Turn On or Turns Off Unexpectedly](#)

[Scanner Button Does Not Work as Expected](#)

[Scanning Software Does Not Operate Correctly](#)

[Cannot Start Epson Scan 2](#)

[Original Feeds Incorrectly in Scanner](#)

[Original Jams in Scanner](#)

[Scanning is Slow](#)

[Cannot Scan Over a Network](#)

Parent topic: [Solving Problems](#)

Scanner Does Not Turn On or Turns Off Unexpectedly

If the scanner does not turn on or if it turns off unexpectedly, try these solutions:

- Make sure the AC adapter is securely connected to the scanner and to a working electrical outlet.
- If the scanner turns off unexpectedly, you may need to adjust the setting in the Epson Scan 2 Utility.
- You may need to adjust the **Sleep Timer** and **Power Off Timer** settings on the control panel.

Parent topic: [Solving Scanning Problems](#)

Related tasks

[Changing the Sleep Timer Settings](#)

[Changing the Power Off Timer Settings](#)

Scanner Button Does Not Work as Expected

If the scanner button does not start the correct program or perform the correct action, try these solutions:

- Check the USB cable connection between the computer and scanner if you are connecting via USB.
- In Windows, be sure that the scanner is listed under **Imaging Devices** in the Device Manager.
- Make sure Document Capture Pro (Windows) or Document Capture (Mac) is installed correctly. If necessary, uninstall and reinstall it.
- Make sure you have assigned the correct job to the scanner button and change it, if necessary.
- Check the status of the lights and make sure the scanner is ready to scan.
- Make sure Epson Scan 2 and other applications are installed correctly. If necessary, uninstall and reinstall it.

Parent topic: [Solving Scanning Problems](#)

Scanning Software Does Not Operate Correctly

If your scanning software does not operate correctly, try these solutions:

- Make sure your computer has adequate memory and meets the system requirements for your operating system.
- Make sure your computer is not running in a power-saving mode, such as sleep or standby. If so, wake your system and restart your scanning software.
- Make sure the scanner is turned on.
- Make sure the connection between the scanner and your computer is secure.
- If you upgraded your operating system but did not reinstall your scanning software, try reinstalling it.
- In Windows, be sure that the scanner is listed under **Imaging Devices** in the Device Manager.
- Check that the correct scanner is selected using the Epson Scan 2 Utility.
- Check that the correct setting is assigned to the scanner button in Document Capture Pro (Windows) or Document Capture (Mac).
- Make sure the scanning software is installed.
- Connect the scanner directly to the computer. The scanner may not work properly when connected through a USB hub.
- Document Capture Pro (Windows) does not support Windows Vista or Windows server, so use Epson Scan 2 for scanning instead.

- If you are using a TWAIN-compliant program, make sure that the correct product is selected as the **Scanner** or **Source** setting.
- Make sure the **PC Connection via USB** setting is not disabled on the control panel.
- If you are using the scanner over a network, make sure the network cable is securely connected.

Parent topic: [Solving Scanning Problems](#)

Related concepts

[Uninstall Your Scanner Software](#)

Related references

[Windows System Requirements](#)

[Mac System Requirements](#)

Cannot Start Epson Scan 2

If you cannot start Epson Scan 2, try these solutions:

- Make sure your scanner appears in the Epson Scan 2 Utility.
- Make sure your scanner is turned on and any interface cables are securely connected at both ends.
- Make sure your computer is not running in a power-saving mode, such as sleep or standby. If so, wake your system and restart Epson Scan 2.
- Connect the scanner directly to the computer. The scanner may not work properly when connected through a USB hub.
- If you connected the scanner using a USB cable, make sure it is connected directly to your computer or through only one USB hub.
- If you are using the scanner over a network, make sure the network cable is securely connected.
- If you are using the scanner over a network, make sure your scanner is displayed in the Scanner Settings screen. If your scanner is not displayed in the list, click **Enable Editing** and click **Add**. Add your scanner on the Add Network Scanner screen.
- Make sure the **PC Connection via USB** setting is not disabled on the control panel.
- If you upgraded your operating system but did not reinstall Epson Scan 2, try reinstalling it.
- If you are using a TWAIN-compliant program, make sure that the correct product is selected as the **Scanner** or **Source** setting.

Parent topic: [Solving Scanning Problems](#)

Related concepts

[Uninstall Your Scanner Software](#)

Related references

[Windows System Requirements](#)

[Mac System Requirements](#)

Original Feeds Incorrectly in Scanner

If you have problems feeding originals in your scanner, try these solutions:

- If multiple pages feed at once, try the following:
 - Remove the originals, fan the edges to separate the sheets, if necessary, and reload them.
 - Load fewer originals at a time.
 - Load only originals that meet the specifications for your scanner.
 - Clean inside the scanner and replace the roller assembly kit, if necessary.
 - Check the pickup rollers and clean, if necessary.
 - Scan the originals one by one using the **Automatic Feeding Mode** setting in Epson Scan 2.
 - Select **Slow** on the scanner control panel to slow down the scanning speed.
 - Use **Automatic Feeding Mode** in Epson Scan 2 and scan originals one at a time.
 - Use the optional carrier sheet for thin, folded, or irregularly shaped originals.
- If you see a double feed error in the Epson Scan 2 window or the Document Capture Pro window, start Epson Scan 2, select the **Main Settings** tab, select the **Detect Double Feed** setting, and select **Off**.

Parent topic: [Solving Scanning Problems](#)

Related references

[User Replaceable Epson Scanner Parts](#)

Related tasks

[Cleaning Inside Your Scanner](#)

Related topics

[Loading Originals](#)

Original Jams in Scanner

If an original has jammed inside the scanner, follow these steps:

1. Turn off your scanner.
2. Remove all originals from the input tray.
3. Pull down the cover open lever and open the scanner cover.

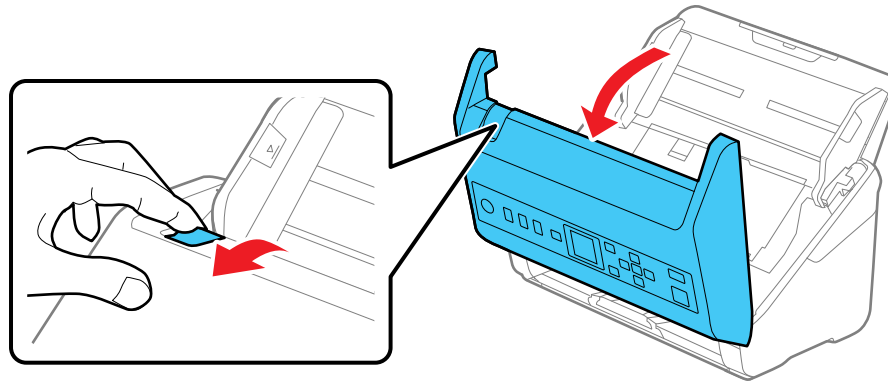

4. Gently pull out any jammed originals from inside the scanner.

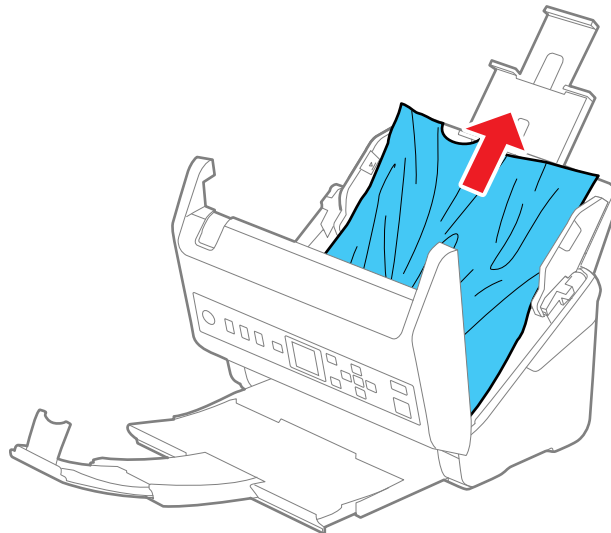

5. Gently pull out any jammed originals from the output tray.

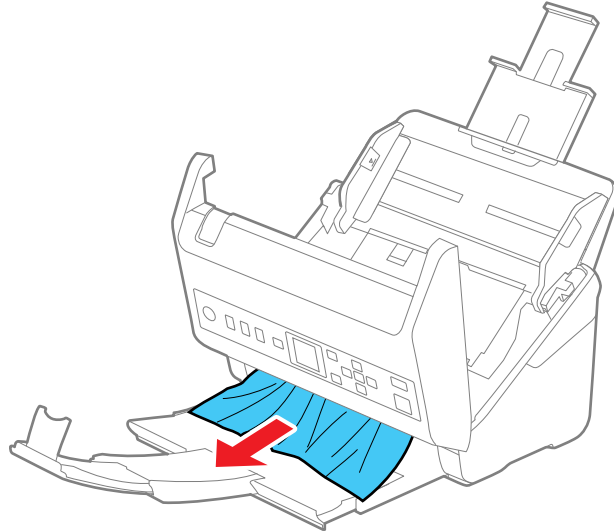

6. Close the scanner cover.

7. Carefully follow all loading instructions when you reload originals.

If originals jam in the scanner frequently, try the following:

- Select on the scanner control panel to slow down the scanning speed.
- Select on the scanner control panel to slow down the scanning speed.
- Clean inside the scanner and clean the rollers.
- Close the output tray and let the originals fall freely onto the surface below the scanner.

Parent topic: [Solving Scanning Problems](#)

Related tasks

[Cleaning Inside Your Scanner](#)

Related topics

[Loading Originals](#)

Scanning is Slow

If scanning becomes slow, try these solutions:

- Scan your original at a lower resolution, if possible.
- Make sure your system meets the requirements for your operating system. If you are scanning a high-resolution image, you may need more than the minimum requirements. If necessary, increase your system's memory or reduce the resolution.
- If scanning becomes slower after scanning continuously with the ADF for a long time, the scanner may have automatically slowed down to protect the scanner mechanism from overheating or becoming damaged. Let the scanner rest with the power on for 30 minutes, then try scanning again.
- Make sure **Slow** is set to **Off** on the scanner control panel.
- If you are running virus protection or other security software, exclude the TWAIN.log files from monitoring or set the TWAIN.log file as read only. See your virus protection or security software instructions for details. The TWAIN.log file is saved in C:\Users\\AppData\Local\Temp.

Note: You may need to unhide system folders to view files in that location.

- If you are scanning over a network, factors such as interference, network traffic, or weak signal strength may affect your scanning speed.
- Computers with USB 3.0 (SuperSpeed) or USB 2.0 (Hi-Speed) ports can scan faster than those with USB 1.1 ports. If you are using a USB 3.0 or 2.0 port with the scanner, make sure it meets the system requirements.

Parent topic: [Solving Scanning Problems](#)

Related references

[Windows System Requirements](#)

[Mac System Requirements](#)

Cannot Scan Over a Network

If you have problems scanning over a network, try these solutions:

- Restart the scanner and check the IP address on the scanner control panel.
- Make sure the Ethernet hub is turned on.
- Restart the Ethernet hub, wait for approximately one minute after restarting, then check the connection again.

- The order in which the Ethernet hub and scanner are turned on may cause a temporary connection error. Restart the scanner, wait for approximately one minute after restarting, then check the connection again.
- If network communication was interrupted while starting Epson Scan 2, exit Epson Scan 2, wait a few seconds, and restart it. If Epson Scan 2 cannot restart, turn off your scanner, turn it back on, and try starting Epson Scan 2 again.
- Check the network connection setting in the Epson Scan 2 Utility.
- Make sure the Ethernet cable is connected securely. If the connection status light on the Ethernet hub is off, check the light status by connecting the Ethernet cable to another port or changing the Ethernet cable. If this does not solve the problem, replace the Ethernet hub.
- If you see a message telling you the product is not available, there may be a communication error between the scanner and computer. Restart the scanner.
- If your network uses a firewall, the scanner may not be discovered by the Epson Scan 2 Utility. Open the Epson Scan 2 Utility, enter the IP address for your scanner, and click **Add**.
- If there is an IP address conflict, the network connection may become unavailable. Check the IP address for each device and assign unique IP addresses.
- Make sure the scanner and Ethernet hub connection modes match. You can change the connection modes using EpsonNet Config. See the [Administrator's Guide](#) for details.
- Restart the computer.

Parent topic: [Solving Scanning Problems](#)

Solving Scanned Image Quality Problems

Check these sections if a scanned image on your computer screen has a quality problem.

Note: For solutions when using Document Capture Pro (Windows) or Document Capture (Mac) software, see the Document Capture Pro (Windows) or Document Capture (Mac) help utility.

[Back of Original Image Appears in Scanned Image](#)

[Scanned Characters are Blurry](#)

[Characters are not Recognized During Conversion to Editable Text \(OCR\)](#)

[Ripple Patterns Appear in an Image](#)

[Spots or Lines Appear in All Scanned Images](#)

[Scanned Image is Cropped](#)

Parent topic: [Solving Problems](#)

Back of Original Image Appears in Scanned Image

If an image from the back of a thin original appears in your scanned image, make sure you selected the correct Image Type setting for your original and select the **Text Enhancement** setting in Epson Scan 2. You can also select the **Remove Background** setting in Epson Scan 2.

Note: If you select **Color** as the Image Type setting, you can change the level from Standard to High to remove more of the background.

Parent topic: [Solving Scanned Image Quality Problems](#)

Related references

[Image Format Options](#)

Related tasks

[Scanning in Epson Scan 2](#)

Scanned Characters are Blurry

If characters in your scanned images are blurry, try these solutions:

- Make sure you do not move the scanner or original while scanning.
- Operate the scanner on a flat, stable surface.
- Adjust these Epson Scan 2 settings (if available) and try scanning again:
 - Select the **Text Enhancement** setting.
 - If the **Image Type** setting is **Black & White**, adjust the **Threshold** setting.
 - Increase the **Resolution** setting.
 - Set the **Image Type** to **Grayscale**.
 - If you are scanning in JPEG format, change the compression level. Click **Options** in the Image Format menu and change the **Image Quality** setting.

Parent topic: [Solving Scanned Image Quality Problems](#)

Related references

[Image Format Options](#)

Related tasks

[Scanning in Epson Scan 2](#)

Characters are not Recognized During Conversion to Editable Text (OCR)

If characters in your scanned images are not recognized during OCR conversion, try these solutions:

- Make sure your original is loaded straight on your product.
- Use an original with clear text.
- Adjust these Epson Scan 2 settings (if available) and try scanning again:
 - Select the correct **Image Type** setting.
 - If the **Image Type** is set to **Black & White**, select **Text Enhancement**. If the Image Type is set to **Color** or **Grayscale**, change the **Text Enhancement** setting to **High**.
 - Select or adjust the **Text Enhancement** setting.
 - If the **Image Type** is set to **Black & White**, adjust the **Threshold** setting.
 - Set the **Image Type** to **Grayscale**.
- Set the scanning resolution between 200 and 600 dpi.
- If the original document is in landscape mode, set the **Rotate** setting to **Auto** in Epson Scan 2.
- If you are using OCR software, check the manual for any additional adjustments.
- Scan thermal paper receipts as soon as possible. They may deteriorate due to age or friction.
- When saving to Microsoft Office or Searchable PDF files, check that the correct languages are selected. Check the language in each save setting window.

Parent topic: [Solving Scanned Image Quality Problems](#)

Related references

[Image Format Options](#)

Related tasks

[Scanning in Epson Scan 2](#)

Ripple Patterns Appear in an Image

You may see a ripple pattern (called a moiré) in scanned images of printed documents. This is caused by interference from differing pitches in the scanner's screen and your original's halftone screen. To reduce this effect, adjust these Epson Scan 2 settings (if available) and try scanning again:

- Select the **Descreening** setting on the Advanced Settings tab.
- Select a lower **Resolution** setting.

Parent topic: [Solving Scanned Image Quality Problems](#)

Related references

[Image Format Options](#)

Related tasks

[Scanning in Epson Scan 2](#)

Spots or Lines Appear in All Scanned Images

If spots or lines appear in all your scanned images, try these solutions:

- Make sure the surface of your original is clean.
- Make sure there is no debris or dirt inside the ADF.
- Disconnect any connected cables and clean inside the scanner.
- Check the rollers and clean, if necessary.
- Enable the **Detect Glass Dirt** setting on the control panel. (Press the  home button, select **Settings** > **Scanner Settings** > **Detect Glass Dirt**, and select **On-Low**, if the alert displays a misdetection, or **On-High** if dirt is not detected.) When an alert displays on the control panel, clean the glass scanning surfaces inside your scanner using a genuine Epson cleaning kit or a soft, moist cloth.

Note: If there are scratches on the glass surface, the alert screen may continue to appear even after cleaning the glass. Contact Epson for information about replacing the glass.

- Avoid scanning in direct sunlight.

Parent topic: [Solving Scanned Image Quality Problems](#)

Scanned Image is Cropped

If the edges of a scanned image are cropped, try the following solutions:



- Select **Auto Detect** as the Document Size setting in Epson Scan 2, Document Capture Pro.
- In Epson Scan 2, select the **Main Settings** tab. Select **Document Size** > **Settings** and adjust the cropping area shown in the **Crop Margins for Size "Auto"** setting. In Document Capture Pro, select **Detailed Settings** from the Scan window. Click **Configuration** and select the **Document** tab. Adjust the cropping area shown in the **Crop Margins for Size "Auto"** setting.
- In Epson Scan 2, select the **Advanced Settings** tab. Make sure the **Edge Fill** setting is set to **None**.
- **Document Capture Pro (Windows):** Select **Scan Settings** > **Detailed Settings** from the Scan window. Select **Document Size** and then select the **Auto Detect** setting.

- **Document Capture (Mac):** Click the  Scan button and select **Main Settings** from the Scan window. Select **Document Size** and then adjust the cropping area shown in the **Crop Margins for Size "Auto"** setting.

Parent topic: [Solving Scanned Image Quality Problems](#)

Resetting the Epson Scan 2 Settings

If you continue to experience image quality problems after trying all possible solutions, you may need to reset the Epson Scan 2 settings using the Epson Scan 2 Utility.

1. Do one of the following to start the Epson Scan 2 Utility:
 - **Windows 10:** Click  > **EPSON** > **Epson Scan 2 Utility**.
 - **Windows 8.x:** Navigate to the **Apps** screen and select **Epson Scan 2 Utility**.
 - **Windows (other versions):** Click  or **Start**, and select **All Programs** or **Programs**. Select **EPSON** > **Epson Scan 2 Utility**.
 - **Mac:** Open the **Applications** folder, open the **Epson Software** folder, and select **Epson Scan 2 Utility**.
2. Click the **Other** tab.
3. Click **Reset**.

Note: If resetting the Epson Scan 2 settings does not solve your problem, uninstall your scanner software and re-install it.

Parent topic: [Solving Problems](#)

Uninstall Your Scanner Software

If you have a problem that requires you to uninstall and re-install your software, follow the instructions for your operating system.



[Uninstalling Scanner Software - Windows](#)

[Uninstalling Scanner Software - Mac](#)

Parent topic: [Solving Problems](#)

Uninstalling Scanner Software - Windows

You can uninstall and then re-install your scanner software to solve certain problems.

1. Exit all applications currently running on your computer.
2. Turn off the scanner.
3. Disconnect any interface cables.
4. Do the following to uninstall each of your scanning software programs and follow any on-screen instructions:
 - **Windows 10:** Click  and select  (Settings) > **Apps** > **Apps & features**. Select the scanner software program and click **Uninstall**.
 - **Windows 8.x:** Navigate to the **Apps** screen and select **Control Panel** > **Programs** > **Programs and Features**. Select the scanner software program and click **Uninstall/Change**.
 - **Windows 7:** Open the Windows **Control Panel** utility. Select **Programs and Features**. (In Classic view, select **Programs** and click **Uninstall a program**.) Select the scanner software program and click **Uninstall/Change**.
5. Restart your computer, then see the *Start Here* sheet to re-install your software.

Note: If you find that re-installing your scanner software does not solve a problem, contact Epson.

Parent topic: [Uninstall Your Scanner Software](#)

Uninstalling Scanner Software - Mac

In most cases, you do not need to uninstall your scanner software before re-installing it. However, you can download the Uninstaller utility from the Epson support website to uninstall your scanner software as described here.

1. To download the Uninstaller utility, visit epson.com/support (U.S.), epson.ca/support (Canada), or latin.epson.com/support (Caribbean) and select your product.
2. Follow the instructions on the screen to install the Uninstaller utility.
3. Quit all applications currently running on your Mac.
4. Double-click the **Uninstaller** icon.
5. In the Epson Uninstaller screen, select the checkbox for each software program you want to uninstall.
6. Click **Uninstall**.
7. Follow the on-screen instructions to uninstall the software.
8. To reinstall your scanner software, see the *Start Here* sheet for instructions.

Note: If you find that re-installing your scanner software does not solve a problem, contact Epson.

Parent topic: [Uninstall Your Scanner Software](#)

Where to Get Help (U.S. and Canada)

If you need to contact Epson for technical support services, use the following support options.

Internet Support

Visit Epson's support website at epson.com/support (U.S.) or epson.ca/support (Canada) and select your product for solutions to common problems with your product. You can download utilities and documentation, get FAQs and troubleshooting advice, or e-mail Epson with your questions.

Speak to a Support Representative

Before you call Epson for support, please have the following information ready:

- Product name
- Product serial number (located on a label on the product)
- Proof of purchase (such as a store receipt) and date of purchase
- Computer configuration
- Description of the problem

Then call:

- U.S.: (562) 276-4300, 6 AM to 8 PM, Pacific Time, Monday through Friday, and 7 AM to 4 PM, Pacific Time, Saturday
- Canada: (905) 709-3839, 6 AM to 8 PM, Pacific Time, Monday through Friday, and 7 AM to 4 PM, Pacific Time, Saturday

Days and hours of support are subject to change without notice. Toll or long distance charges may apply.

Note: For help using any other software on your system, see the documentation for that software for technical support.

Purchase Supplies and Accessories

You can purchase genuine Epson accessories at epson.com (U.S. sales) or epson.ca (Canadian sales). You can also purchase accessories from an Epson authorized reseller. To find the nearest one, call 800-GO-EPSON (800-463-7766) in the U.S. or 800-807-7766 in Canada.

Parent topic: [Solving Problems](#)

Where to Get Help (Latin America)

If you need additional help with your Epson product, contact Epson.

Epson provides these technical support services:

Internet Support

Visit Epson's support website at latin.epson.com/support and select your product for solutions to common problems. You can download drivers and documentation, get FAQs and troubleshooting advice, or e-mail Epson with your questions.

Speak to a Support Representative

Before you call Epson for support, please have the following information ready:

- Product name
- Product serial number (located on a label on the product)
- Proof of purchase (such as a store receipt) and date of purchase
- Computer configuration
- Description of the problem

Then call:

Country	Telephone
Argentina	(54 11) 5167-0300 0800-288-37766
Bolivia*	800-100-116
Brazil	State capitals and metropolitan areas: 3004-6627 Other areas: 0800-377-6627 / 0800-EPSONBR
Chile	(56 2) 2484-3400
Colombia	Bogota: (57 1) 592-2200 Other cities: 018000-915235
Costa Rica	800-377-6627
Ecuador*	1-800-000-044

Country	Telephone
El Salvador*	800-6570
Guatemala*	1-800-835-0358
Mexico	Mexico City: (52 55) 1323-2052 Other cities: 01-800-087-1080
Nicaragua*	00-1-800-226-0368
Panama*	00-800-052-1376
Paraguay	009-800-521-0019
Peru	Lima: (51 1) 418-0210 Other cities: 0800-10-126
Uruguay	00040-5210067
Venezuela	(58 212) 240-1111

* Contact your local phone company to call this toll-free number from a mobile phone.

If your country does not appear in the list, contact the sales office in the nearest country. Toll or long distance charges may apply.

Purchase Supplies and Accessories

You can purchase genuine Epson accessories from an Epson authorized reseller. To find the nearest reseller, visit latin.epson.com/support or call your nearest Epson sales office.

Parent topic: [Solving Problems](#)

Technical Specifications

These sections list the technical specifications for your scanner.

Note: Epson offers a recycling program for end of life Epson products. Please go to [this site](#) (U.S) or [this site](#) (Canada) for information on how to return your Epson products for proper disposal.

[Windows System Requirements](#)

[Mac System Requirements](#)

[General Specifications](#)

[Dimension Specifications](#)

[Electrical Specifications](#)

[Environmental Specifications](#)

[Network Interface Specifications](#)

[Safety and Approvals Specifications](#)

Windows System Requirements

To use your product and its software, your computer should use one of these Microsoft operating systems:

- Windows 10
- Windows 8.x
- Windows 7
- Windows Vista (not supported by Document Capture Pro 2.0 or later)
- Windows XP Professional x64 Edition (not supported by Document Capture Pro 2.0 or later)
- Windows XP SP3 (not supported by Document Capture Pro 2.0 or later)
- Windows Server 2016
- Windows Server 2012R2
- Windows Server 2012
- Windows Server 2008R2
- Windows Server 2008
- Windows Server 2003R2

- Windows Server 2003 SP2

Note: For the latest product software available for your operating system, visit the Epson support site at epson.com/support (U.S.), epson.ca/support (Canada), or latin.epson.com/support (Caribbean), select your product, and select **Downloads**.

Parent topic: [Technical Specifications](#)

Mac System Requirements

To use your product and its software, your Mac should use one of these operating systems:

- macOS 11.x
- macOS 10.15.x
- macOS 10.14.x
- macOS 10.13.x
- macOS 10.12.x
- OS X 10.11.x
- OS X 10.10.x
- OS X 10.9.x
- OS X 10.8.x
- OS X 10.7.5

Note: The UNIX File System (UFS) for OS X and Fast User Switching on OS X is not supported.

For the latest product software available for your operating system, visit the Epson support site at epson.com/support (U.S.), epson.ca/support (Canada), or latin.epson.com/support (Caribbean), select your product, and select **Downloads**.

Parent topic: [Technical Specifications](#)

General Specifications

Scanner type	Sheet feed, one pass duplex, color
Photoelectric device	CIS

Effective pixels	5100 × 9300 pixels at 600 dpi 2550 × 64,500 pixels at 300 dpi
Document size	Maximum: 8.5 × 240 inches (215.9 × 6096 mm) Minimum: 2 × 2 inches (50.8 × 50.8 mm)
Paper input	Facedown loading
Paper output	Facedown ejection
Paper capacity	100 sheets of paper at 21 lb (80 g/m ²) weight
Scanning resolution	600 dpi (main scan) 600 dpi (sub scan)
Output resolution	50 to 1200 dpi in 1 dpi increments 53 inches (1346.0 mm) or less: up to 600 dpi 215 inches (5461.0 mm) or less: up to 300 dpi 220 inches (6096.0 mm) or less: up to 200 dpi
Color Depth	Color: 30 bits per pixel internal (10 bits per pixel per color) 24 bits per pixel external (8 bits per pixel per color) Grayscale: 10 bits per pixel internal 8 bits per pixel external Black-and-white: 10 bits per pixel internal 1 bit per pixel external
Interface	Hi-speed USB Note: You cannot use a USB connection when using the Document Capture Pro Server Authenticate Edition.
Light source	RGB LED

Parent topic: [Technical Specifications](#)

Dimension Specifications

Height	6.6 inches (167 mm)
Width	11.7 inches (296 mm)
Depth	6.7 inches (169 mm)
Weight	7.9 lb (3.6 kg)

Note: Dimensions do not include projecting parts.

Parent topic: [Technical Specifications](#)

Electrical Specifications

Scanner

Note: Check the label on the scanner and the AC adapter for voltage information. Power consumption varies depending on operating conditions or whether an option is installed.

Rated DC input power supply voltage	24 V DC
Rated DC input current	1 A
Power consumption	USB Connection: Operating: 13 W (approximate) Ready mode: 5.9 W (approximate) Sleep mode: 1.2 W (approximate) Power off mode: 0.1 W (approximate) Ethernet Connection: Operating: 14 W (approximate) Ready mode: 5.9 W (approximate) Sleep mode: 1.5 W (approximate) Power off mode: 0.1 W (approximate)

AC Adapter

AC adapter model	100 to 240 V AC model: A461H
Rated input current	1 A
Rated frequency range	50 to 60 Hz
Rated output power supply voltage	24 V DC
Rated output current	1 A

Parent topic: [Technical Specifications](#)

Environmental Specifications

Temperature	Operating: 41 to 95 °F (5 to 35 °C) Storage: -13 to 140 °F (-25 to 60 °C)
Humidity (non-condensing)	Operating: 15 to 80% RH Storage: 15 to 85% RH
Operating conditions	Ordinary office or home conditions

Note: Avoid operating the scanner in direct sunlight, near a strong light source, or in extremely dusty conditions.

Parent topic: [Technical Specifications](#)

Network Interface Specifications

Standards	IEEE802.3i (10BASE-T)* IEEE802.3u (100BASE-TX)* IEEE802.3ab (1000BASE-T)* IEEE802.3az (Energy Efficient Ethernet); connected device should be IEEE802.3az compliant
Communication mode	Auto, 10 Mbps Full duplex, 10Mbps Half duplex, 100 Mbps Full Duplex, 100 Mbps Half duplex

Connector RJ-45

* Use a category 5e or higher STP (Shielded twisted pair) cable to prevent risk of radio interference.

Parent topic: [Technical Specifications](#)

Safety and Approvals Specifications

Scanner

United States EMC: FCC part 15 Subpart B class B

Canada EMC: CAN ICES-3 (B)/NMB-3 (B)

AC Adapter (A471H)

United States Safety: UL60950-1

EMC: FCC part 15 Subpart B class B

Canada Safety: CAN/CSA C22.2 No. 60950-1

EMC: CAN ICES-3 (B)/NMB-3 (B)

Parent topic: [Technical Specifications](#)

Notices

Check these sections for important notices about your scanner.

Note: Epson offers a recycling program for end of life Epson products. Please go to [this site](#) (U.S) or [this site](#) (Canada) for information on how to return your Epson products for proper disposal.

[Important Safety Instructions](#)

[Restrictions on Copying](#)

[Default Delay Times for Power Management for Epson Products](#)

[Binding Arbitration and Class Waiver](#)

[Trademarks](#)

[Copyright Notice](#)

Important Safety Instructions

Follow these safety instructions when setting up and using the scanner:

- Read all these instructions, and follow all warnings and instructions marked on the scanner.
- Place the scanner close enough to the computer for the interface cable to reach it easily.
- Do not use with wet hands.
- When connecting this product to a computer or other device with a cable, ensure the correct orientation of the connectors. Each connector has only one correct orientation. Inserting a connector in the wrong orientation may damage both devices connected by the cable.
- Do not insert objects into any opening as they may touch dangerous voltage points or short out parts. Beware of electrical shock hazards.
- Place the product on a flat, stable surface that extends beyond the base of the product in all directions. If you place the product by the wall, leave at least 3.9 inches (10 cm) between the back of the product and the wall.
- After replacing consumable parts, dispose of them correctly following the rules of your local authority. Do not disassemble them.
- Do not place or store the scanner outdoors, in a car, near excessive dirt or dust, water, heat sources, or in locations subject to shocks, vibrations, condensation, high temperature or humidity, direct sunlight, strong light sources, or rapid changes in temperature or humidity.

- Never disassemble, modify, or attempt to repair the scanner or a scanner option by yourself except as specifically explained in this guide.

AC Adapter

- Do not place or store the AC adapter outdoors, in a car, near excessive dirt or dust, water, heat sources, or in locations subject to shocks, vibrations, condensation, high temperature or humidity, direct sunlight, strong light sources, or rapid changes in temperature or humidity.
- Place the scanner and the AC adapter near an electrical outlet where the adapter can be easily unplugged.
- The AC power cord should be placed to avoid abrasions, cuts, fraying, crimping, and kinking.
- Do not place objects on top of the AC power cord and do not allow the AC adapter or the power cord to be stepped on or run over. Be particularly careful to keep the AC power cord straight at the end and the point where it enters the AC adapter.
- Use only the AC adapter that comes with your scanner. Using any other adapter could cause fire, electrical shock, or injury.
- The AC adapter is designed for use with the scanner with which it was included. Do not attempt to use it with other electronic devices unless specified.
- Use only the type of power source indicated on the AC adapter's label, and always supply power directly from a standard domestic electrical outlet with the AC adapter that meets the relevant local safety standards.
- Avoid using outlets on the same circuit as photocopiers or air control systems that regularly switch on and off.
- If you use an extension cord with the scanner, make sure the total ampere rating of the devices plugged into the extension cord does not exceed the cord's ampere rating. Also, make sure the total ampere rating of all devices plugged into the wall outlet does not exceed the wall outlet's ampere rating.
- Never disassemble, modify, or attempt to repair the AC adapter by yourself except as specifically explained in the scanner's guides.
- If damage occurs to the plug, replace the cord set or consult a qualified electrician. If there are fuses in the plug, make sure you replace them with fuses of the correct size and rating.
- Unplug the scanner and the AC adapter, and refer servicing to qualified service personnel under the following conditions: The AC adapter or plug is damaged; liquid has entered the scanner or the AC adapter; the scanner or the AC adapter has been dropped or the case has been damaged; the scanner or the AC adapter does not operate normally or exhibits a distinct change in performance. (Do not adjust controls that are not covered by the operating instructions.)

- Unplug the scanner and the AC adapter before cleaning. Clean with a damp cloth only. Do not use liquid or aerosol cleaners.
- If you are not going to use the scanner for a long period, be sure to unplug the AC adapter from the electrical outlet.

LCD Screen

- The LCD screen may have uneven brightness or a few small bright or dark spots. This is normal and does not indicate damage.
- Use only a dry, soft cloth to clean the LCD screen. Do not use liquid or chemical cleansers.
- If the LCD screen is damaged, contact Epson. If the liquid crystal solution gets on your hands, wash them thoroughly with soap and water. If the liquid crystal solution gets into your eyes, flush them immediately with water. If discomfort or vision problems remain after a thorough flushing, see a doctor immediately.
- Do not press too hard on the LCD screen or subject it to heavy impacts.
- Do not use a pointy or sharp object, such as a pen or your fingernail, to operate the LCD screen.
- If the LCD screen chips or cracks, do not touch or attempt to remove the broken pieces; contact Epson for support.
- Do not subject your product to sudden changes in temperature or humidity; this may cause condensation to develop inside the LCD screen and degrade its performance.

Parent topic: [Notices](#)

Restrictions on Copying

Observe the following restrictions to ensure responsible and legal use of your scanner.

Copying of the following items is prohibited by law:

- Bank bills, coins, government-issued marketable securities, government bond securities, and municipal securities
- Unused postage stamps, pre-stamped postcards, and other official postal items bearing valid postage
- Government-issued revenue stamps, and securities issued according to legal procedure

Exercise caution when copying the following items:

- Private marketable securities (stock certificates, negotiable notes, checks, etc.), monthly passes, concession tickets, etc.
- Passports, driver's licenses, warrants of fitness, road passes, food stamps, tickets, etc.

Note: Copying these items may also be prohibited by law.

Restriction on disassembling and decompiling

You may not disassemble, decompile, or otherwise attempt to derive the source code of any software included with this product.

Parent topic: [Notices](#)

Default Delay Times for Power Management for Epson Products

This product will enter sleep mode after a period of nonuse. This is to ensure that the product meets Energy Star standards of energy efficiency. More energy savings can be achieved by setting the time to sleep to a shorter interval.

Parent topic: [Notices](#)

Binding Arbitration and Class Waiver

1. DISPUTES, BINDING INDIVIDUAL ARBITRATION, AND WAIVER OF CLASS ACTIONS AND CLASS ARBITRATIONS

1.1 Disputes. The terms of this Section 1 shall apply to all Disputes between you and Epson. The term "Dispute" is meant to have the broadest meaning permissible under law and includes any dispute, claim, controversy or action between you and Epson arising out of or relating to this Agreement, Epson branded products (hardware and including any related software), or other transaction involving you and Epson, whether in contract, warranty, misrepresentation, fraud, tort, intentional tort, statute, regulation, ordinance, or any other legal or equitable basis. "DISPUTE" DOES NOT INCLUDE IP CLAIMS, or more specifically, a claim or cause of action for (a) trademark infringement or dilution, (b) patent infringement, (c) copyright infringement or misuse, or (d) trade secret misappropriation (an "IP Claim"). You and Epson also agree, notwithstanding Section 1.6, that a court, not an arbitrator, may decide if a claim or cause of action is for an IP Claim.

1.2 Binding Arbitration. You and Epson agree that all Disputes shall be resolved by binding arbitration according to this Agreement. **ARBITRATION MEANS THAT YOU WAIVE YOUR RIGHT TO A JUDGE OR JURY IN A COURT PROCEEDING AND YOUR GROUNDS FOR APPEAL ARE LIMITED.**

Pursuant to this Agreement, binding arbitration shall be administered by JAMS, a nationally recognized arbitration authority, pursuant to its code of procedures then in effect for consumer related disputes, but excluding any rules that permit joinder or class actions in arbitration (for more detail on procedure, see Section 1.6 below). You and Epson understand and agree that (a) the Federal Arbitration Act (9 U.S.C. §1, et seq.) governs the interpretation and enforcement of this Section 1, (b) this Agreement memorializes a transaction in interstate commerce, and (c) this Section 1 shall survive termination of this Agreement.

1.3 Pre-Arbitration Steps and Notice. Before submitting a claim for arbitration, you and Epson agree to try, for sixty (60) days, to resolve any Dispute informally. If Epson and you do not reach an agreement to resolve the Dispute within the sixty (60) days, you or Epson may commence an arbitration. Notice to Epson must be addressed to: Epson America, Inc., ATTN: Legal Department, 3840 Kilroy Airport Way, Long Beach, CA 90806 (the "Epson Address"). The Dispute Notice to you will be sent to the most recent address Epson has in its records for you. For this reason, it is important to notify us if your address changes by emailing us at EAILEgal@ea.epson.com or writing us at the Epson Address above. Notice of the Dispute shall include the sender's name, address and contact information, the facts giving rise to the Dispute, and the relief requested (the "Dispute Notice"). Following receipt of the Dispute Notice, Epson and you agree to act in good faith to resolve the Dispute before commencing arbitration.

1.4 Small Claims Court. Notwithstanding the foregoing, you may bring an individual action in the small claims court of your state or municipality if the action is within that court's jurisdiction and is pending only in that court.

1.5 WAIVER OF CLASS ACTIONS AND CLASS ARBITRATIONS. YOU AND EPSON AGREE THAT EACH PARTY MAY BRING DISPUTES AGAINST THE OTHER PARTY ONLY IN AN INDIVIDUAL CAPACITY, AND NOT AS A PLAINTIFF OR CLASS MEMBER IN ANY CLASS OR REPRESENTATIVE PROCEEDING, INCLUDING WITHOUT LIMITATION FEDERAL OR STATE CLASS ACTIONS, OR CLASS ARBITRATIONS. CLASS ACTION LAWSUITS, CLASS-WIDE ARBITRATIONS, PRIVATE ATTORNEY-GENERAL ACTIONS, AND ANY OTHER PROCEEDING WHERE SOMEONE ACTS IN A REPRESENTATIVE CAPACITY ARE NOT ALLOWED. ACCORDINGLY, UNDER THE ARBITRATION PROCEDURES OUTLINED IN THIS SECTION, AN ARBITRATOR SHALL NOT COMBINE OR CONSOLIDATE MORE THAN ONE PARTY'S CLAIMS WITHOUT THE WRITTEN CONSENT OF ALL AFFECTED PARTIES TO AN ARBITRATION PROCEEDING.

1.6 Arbitration Procedure. If you or Epson commences arbitration, the arbitration shall be governed by the rules of JAMS that are in effect when the arbitration is filed, excluding any rules that permit arbitration on a class or representative basis (the "JAMS Rules"), available at <http://www.jamsadr.com> or by calling 1-800-352-5267, and under the rules set forth in this Agreement. All Disputes shall be resolved by a single neutral arbitrator, and both parties shall have a reasonable opportunity to participate in the selection of the arbitrator. The arbitrator is bound by the terms of this Agreement. The arbitrator, and not any federal, state or local court or agency, shall have exclusive authority to resolve all disputes arising out of or relating to the interpretation, applicability, enforceability or formation of this Agreement, including any claim that all or any part of this Agreement is void or voidable. Notwithstanding this broad delegation of authority to the arbitrator, a court may determine the limited question of whether a claim or cause of action is for an IP Claim, which is excluded from the definition of "Disputes" in Section 1.1 above. The arbitrator shall be empowered to grant whatever relief would be available in a court under law or in equity. The arbitrator may award you the same damages as a court could, and may award declaratory or injunctive relief only in favor of the individual party seeking relief and only to the extent necessary to provide relief warranted by that party's individual claim. In some instances, the costs of

arbitration can exceed the costs of litigation and the right to discovery may be more limited in arbitration than in court. The arbitrator's award is binding and may be entered as a judgment in any court of competent jurisdiction.

You may choose to engage in arbitration hearings by telephone. Arbitration hearings not conducted by telephone shall take place in a location reasonably accessible from your primary residence, or in Orange County, California, at your option.

a) Initiation of Arbitration Proceeding. If either you or Epson decides to arbitrate a Dispute, both parties agree to the following procedure:

(i) Write a Demand for Arbitration. The demand must include a description of the Dispute and the amount of damages sought to be recovered. You can find a copy of a Demand for Arbitration at <http://www.jamsadr.com> ("Demand for Arbitration").

(ii) Send three copies of the Demand for Arbitration, plus the appropriate filing fee, to: JAMS, 500 North State College Blvd., Suite 600 Orange, CA 92868, U.S.A.

(iii) Send one copy of the Demand for Arbitration to the other party (same address as the Dispute Notice), or as otherwise agreed by the parties.

b) Hearing Format. During the arbitration, the amount of any settlement offer made shall not be disclosed to the arbitrator until after the arbitrator determines the amount, if any, to which you or Epson is entitled. The discovery or exchange of non-privileged information relevant to the Dispute may be allowed during the arbitration.

c) Arbitration Fees. Epson shall pay, or (if applicable) reimburse you for, all JAMS filings and arbitrator fees for any arbitration commenced (by you or Epson) pursuant to provisions of this Agreement.

d) Award in Your Favor. For Disputes in which you or Epson seeks \$75,000 or less in damages exclusive of attorney's fees and costs, if the arbitrator's decision results in an award to you in an amount greater than Epson's last written offer, if any, to settle the Dispute, Epson will: (i) pay you \$1,000 or the amount of the award, whichever is greater; (ii) pay you twice the amount of your reasonable attorney's fees, if any; and (iii) reimburse you for any expenses (including expert witness fees and costs) that your attorney reasonably accrues for investigating, preparing, and pursuing the Dispute in arbitration. Except as agreed upon by you and Epson in writing, the arbitrator shall determine the amount of fees, costs, and expenses to be paid by Epson pursuant to this Section 1.6d).

e) Attorney's Fees. Epson will not seek its attorney's fees and expenses for any arbitration commenced involving a Dispute under this Agreement. Your right to attorney's fees and expenses under Section 1.6d) above does not limit your rights to attorney's fees and expenses under applicable law; notwithstanding the foregoing, the arbitrator may not award duplicative awards of attorney's fees and expenses.

1.7 Opt-out. You may elect to opt-out (exclude yourself) from the final, binding, individual arbitration procedure and waiver of class and representative proceedings specified in this

Agreement by sending a written letter to the Epson Address within thirty (30) days of your assent to this Agreement (including without limitation the purchase, download, installation of the Software or other applicable use of Epson Hardware, products and services) that specifies (i) your name, (ii) your mailing address, and (iii) your request to be excluded from the final, binding individual arbitration procedure and waiver of class and representative proceedings specified in this Section 1. In the event that you opt-out consistent with the procedure set forth above, all other terms shall continue to apply, including the requirement to provide notice prior to litigation.

1.8 Amendments to Section 1. Notwithstanding any provision in this Agreement to the contrary, you and Epson agree that if Epson makes any future amendments to the dispute resolution procedure and class action waiver provisions (other than a change to Epson's address) in this Agreement, Epson will obtain your affirmative assent to the applicable amendment. If you do not affirmatively assent to the applicable amendment, you are agreeing that you will arbitrate any Dispute between the parties in accordance with the language of this Section 1 (or resolve disputes as provided for in Section 1.7, if you timely elected to opt-out when you first assented to this Agreement).

1.9 Severability. If any provision in this Section 1 is found to be unenforceable, that provision shall be severed with the remainder of this Agreement remaining in full force and effect. **The foregoing shall not apply to the prohibition against class or representative actions as provided in Section 1.5. This means that if Section 1.5 is found to be unenforceable, the entire Section 1 (but only Section 1) shall be null and void.**

Parent topic: [Notices](#)

Trademarks

EPSON® is a registered trademark and EPSON Exceed Your Vision is a registered logomark of Seiko Epson Corporation.

Windows is a registered trademark of Microsoft Corporation in the United States and/or other countries.

Apple, macOS, and OS X are trademarks of Apple Inc., registered in the U.S. and other countries.

General Notice: Other product names used herein are for identification purposes only and may be trademarks of their respective owners. Epson disclaims any and all rights in those marks.



Parent topic: [Notices](#)

Copyright Notice

All rights reserved. No part of this publication may be reproduced, stored in a retrieval system, or transmitted in any form or by any means, electronic, mechanical, photocopying, recording, or otherwise, without the prior written permission of Seiko Epson Corporation. The information contained herein is designed only for use with this Epson product. Epson is not responsible for any use of this information as applied to other products.

Neither Seiko Epson Corporation nor its affiliates shall be liable to the purchaser of this product or third parties for damages, losses, costs, or expenses incurred by purchaser or third parties as a result of: accident, misuse, or abuse of this product or unauthorized modifications, repairs, or alterations to this product, or (excluding the U.S.) failure to strictly comply with Seiko Epson Corporation's operating and maintenance instructions.

Seiko Epson Corporation shall not be liable for any damages or problems arising from the use of any options or any consumable products other than those designated as Original Epson Products or Epson Approved Products by Seiko Epson Corporation.

Seiko Epson Corporation shall not be held liable for any damage resulting from electromagnetic interference that occurs from the use of any interface cables other than those designated as Epson approved Products by Seiko Epson Corporation.

This information is subject to change without notice.

[libTIFF Software Acknowledgment](#)

[A Note Concerning Responsible Use of Copyrighted Materials](#)

[Copyright Attribution](#)

Parent topic: [Notices](#)

libTIFF Software Acknowledgment

Copyright © 1988-1997 Sam Leffler

Copyright © 1991-1997 Silicon Graphics, Inc.

Permission to use, copy, modify, distribute, and sell this software and its documentation for any purpose is hereby granted without fee, provided that (i) the above copyright notices and this permission notice appear in all copies of the software and related documentation, and (ii) the names of Sam Leffler and Silicon Graphics may not be used in any advertising or publicity relating to the software without the specific, prior written permission of Sam Leffler and Silicon Graphics.

THE SOFTWARE IS PROVIDED "AS-IS" AND WITHOUT WARRANTY OF ANY KIND, EXPRESS, IMPLIED OR OTHERWISE, INCLUDING WITHOUT LIMITATION, ANY WARRANTY OF MERCHANTABILITY OR FITNESS FOR A PARTICULAR PURPOSE.

IN NO EVENT SHALL SAM LEFFLER OR SILICON GRAPHICS BE LIABLE FOR ANY SPECIAL, INCIDENTAL, INDIRECT OR CONSEQUENTIAL DAMAGES OF ANY KIND, OR ANY DAMAGES WHATSOEVER RESULTING FROM LOSS OF USE, DATA OR PROFITS, WHETHER OR NOT ADVISED OF THE POSSIBILITY OF DAMAGE, AND ON ANY THEORY OF LIABILITY, ARISING OUT OF OR IN CONNECTION WITH THE USE OR PERFORMANCE OF THIS SOFTWARE.

Parent topic: [Copyright Notice](#)

A Note Concerning Responsible Use of Copyrighted Materials

Epson encourages each user to be responsible and respectful of the copyright laws when using any Epson product. While some countries' laws permit limited copying or reuse of copyrighted material in certain circumstances, those circumstances may not be as broad as some people assume. Contact your legal advisor for any questions regarding copyright law.

Parent topic: [Copyright Notice](#)

Copyright Attribution

© 2020 Epson America, Inc.

10/20

CPD-58844

Parent topic: [Copyright Notice](#)